

Обжимные фитинги

Двухкольцевые



Содержание

Штуцер с внешней резьбой

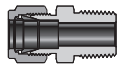

4

Штуцер с внешней резьбой и монтажом на панель

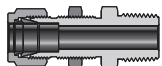

15

Фитинги с внешней резьбой для термопар

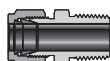

17

Фитинг с внутренней резьбой

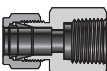

18

Фитинг с внутренней резьбой с креплением на панель

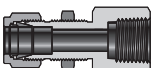

23

Муфты



24

Переходные муфты



25

Переходные муфты



25

Муфта с монтажом на панель

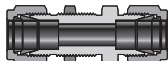

27

Переходная муфта с монтажом на панель

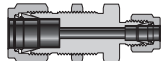

27

Угольник с внешней резьбой

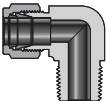

29

Угольник под 45° с внешней резьбой

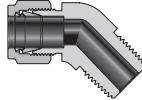

32

Позиционируемый угольник с внешней резьбой

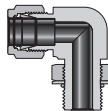

33

Позиционируемый угольник под 45° с внутренней резьбой

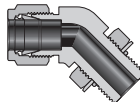

35

Угольник с внутренней резьбой

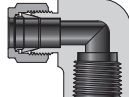

36

Соединительный угольник

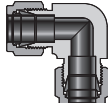

37

Переходной угольник

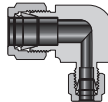

38

Тройник с внешней резьбой снизу

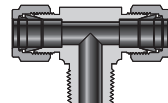

39

Тройник с внешней резьбой сбоку

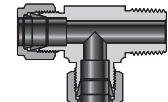

40

Позиционируемый тройник с внешней резьбой снизу

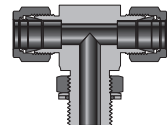

41

Содержание

Позиционируемый тройник с внешней резьбой сбоку

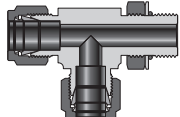

42

Тройник с внутренней резьбой снизу

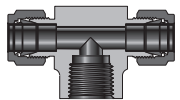

43

Тройник с внутренней резьбой сбоку

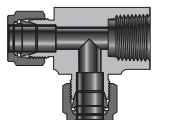

44

Соединительный тройник

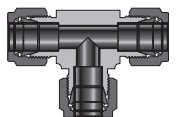

45

Переходной соединительный тройник

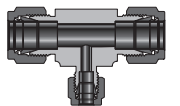

46

Соединительная крестовина

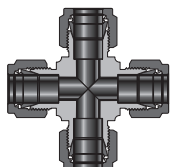

48

Колпак



49

Заглушка



49

Переходники с трубным адаптером

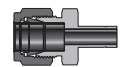

50

Соединитель для фитингов



52

Переходной соединитель для фитингов

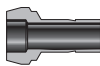

53

Трубный адаптер с внешней резьбой

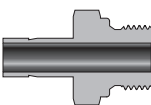

53

Трубный адаптер с внутренней резьбой

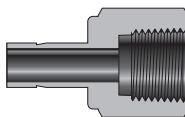

58

Фланцевый переходник

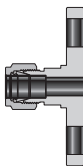

61

Переходник с санитарного фланца

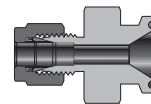

62

Переходник с вакуумного фланца

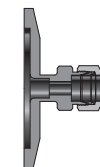

62

Штуцер под приварку

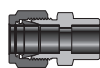

63

Угольники под приварку

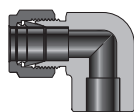

64

Содержание

Гайки

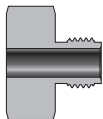

65

Передние обжимные кольца



66

Задние обжимные кольца



66

Комплект обжимных колец и гайки

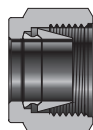

67

Вставки для мягких трубок

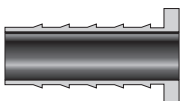

68

Комбинированные уплотнительные кольца



69

Уплотнительные медные кольца для внешней резьбы



70

Уплотнительные медные кольца для манометрической резьбы



70

Уплотнительные кольца из эластомеров



71

Особенности

- Обжимные фитинги уплотняются металл по металлу без использования каких-либо эластомеров
- Обжимные фитинги CIR-LOK спроектированы для работы при давлении значительно превышающем давление трубки
- Стандартный дизайн для всего диапазона размеров трубок
- Жёсткость трубок не должна превышать 85 по Роквеллу
- Доступны размеры фитингов от 1/16 до 2 дюймов и от 2 до 50 мм.
- Фитинги могут быть изготовлены из нержавеющей стали, углеродистой стали, латуни, алюминия, Хастеллоя, Инкоеля и других сплавов.
- Подсеребрённая резьба на гайке фитинга для уменьшения усилия при затяжке и исключения эффекта холодной сварки.
- Фитинги прекрасно работают в вакуумных системах и в системах с сильной вибрацией.

Производительность

- Гидравлический тест (превышение рабочего давления в 1.5 раза): утечек нет
- Сборка разборка фитингов 50 раз: утечек нет
- Тест на четырёхкратное превышение давления: утечек нет
- Тестирование вакуумом при $1 \cdot 10^{-8}$: утечки нет
- Тестирование азотом при полуторакратном превышении давления: утечек нет
- Тестирование с импульсной и вибрационной нагрузкой (импульсы 0,5 - 1.7 Гц, вибрация 23-47 Гц): Утечек нет
- Тест на термоцикличность. Нагрев системы до +80 °С резкое охлаждение до -25 °С и тест на герметичность: утечек нет
- Герметичность при вибрации. Система вибрирует с частотой 45 Гц под давлением 20*106 циклов: утечек нет
- Воздействие открытым огнём (согласно стандарту BS ISO 19921): утечек нет
- Тест на коррозию в течении 168ч: Видимых следов коррозии нет
- Подводный тест (эквивалент глубины 3048): Утечки гелия нет

Стандарты материалов

Материал	Заготовка	Поковки
Нержавеющая сталь марки 316	ASTM A276 ASME SA479, EN 1.4401	ASTM A182 ASME SA182, EN 1.4401
Сплав 20	ASTM B473	ASTM B462
Сплав 400/R-405	ASTM B164, ASME SB164	ASTM B564, ASME SB564
Сплав 600	ASTM B166, ASME SB166	ASTM B564, ASME SB564
Сплав 625	ASTM B446	ASTM B564, ASME SB564
Сплав 825	ASTM B425	ASTM B564, ASME SB564
Сплав C-276	ASTM B574	ASTM B564
Алюминий	ASTM B211	ASTM B247
Латунь	ASTM B16 ASTM B453	ASTM B283
Углеродистая сталь	ASTM A108	—
Дуплекс 2507	ASTM A479	ASTM A182
Титан	ASTM B348	ASTM B381
Тефлон (PFA)	—	ASTM D3307 Type I
Тефлон (PTFE)	ASTM D1710	ASTM D3294

Спецификация по резьбам

Тип резьбы	Справочная спецификация
NPT	ASME B1.20.1, SAE AS71051
ISO/BSP(Цилиндрическая) (На основе DIN 3852) (Фитинги CIR-LOK PPT, BP и BS)	ISO 228, JIS B0202
ISO/BSP(Коническая) (На основе DIN 3852) (Фитинги CIR-LOK BT)	ISO 7, BS EN 10226-1, JIS B0203
ISO/BSP(Манометрическая) (На основе EN 837-1 и 837-3) (CIR-LOK BG)	ISO 228, JIS B0202
Унифицированная (SAE) (CIR-LOK SA фитинги)	ASME B1.1

Рабочее давление резьбы NPT

Давление при комнатной температуре по стандарту ASME B31.3

Размер трубы NPT/ISO	Нержавеющая и углеродистая сталь				Латунь			
	Внешняя		Внутренняя		Внешняя		Внутренняя	
	фунт/кв. дюйм	Бар	фунт/кв. дюйм	Бар	фунт/кв. дюйм	Бар	фунт/кв. дюйм	Бар
1/16	11000	760	6700	460	5500	380	3300	230
1/8	10000	690	6500	440	5000	340	3200	220
1/4	8000	550	6600	450	4000	270	3300	220
3/8	7800	540	5300	360	3900	270	2600	180
1/2	7700	530	4900	330	3800	260	2400	160
3/4	7300	500	4600	320	3600	250	2300	160
1	5300	370	4400	300	2600	180	2200	150
1 1/4	6000	410	5000	350	3000	200	2500	170
1 1/2	5000	340	4600	310	2500	170	2300	150
2	3900	270	3900	270	1900	130	1900	130

Для уточнения давлений по стандарту ASME B31.1:
 Для нержавеющей стали коэффициент 0,94
 Для углеродистой стали коэффициент 0,85
 Для Латунни коэффициент остаётся тем же.

Унифицированная резьба SAE/MS

Рабочие давления по стандарту SAE J1926/3

SAE/MS Размер резьбы	Нержавеющая и углеродистая сталь			
	Непозиционируемые		Позиционируемые	
	фунт/кв. дюйм	Бар	фунт/кв. дюйм	Бар
5/16-24	4568	315	4568	315
7/16-20				
1/2-20				
9/16-18				
3/4-16				
7/8-14	3626	250	2900	200
1 1/16-12				
1 3/16-12	2900	200	2320	160
1 5/16-12				
1 5/8-12	2320	160	1813	125
1 7/8-12				
2 1/2-12				
2 1/2-12	1813	125	1450	100

Фитинги с уплотнительным кольцом из эластомеров имеют меньшие рабочие давления.

Позиционируемые, ISO/BSP Рабочее давление

Давления при комнатной температуре

ISO/BSP Размер внешней трубы, дюйм	Нержавеющая и углеродистая сталь	
	фунт/кв. дюйм	Бар
1/8	4568	315
1/4		
3/8		
1/2	2320	160
3/4		
1		

Виды уплотнения цилиндрических резьб

1. Уплотнение комбинированной прокладкой

- Внешняя резьба по стандарту DIN 3852-2 type A
- Внутренняя резьба по стандарту DIN 3852-2 тип X

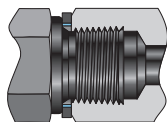

2. Уплотнение медной прокладкой

- Внешнее уплотнение по стандарту DIN 3852-2 тип B
- Внутреннее уплотнение по стандарту DIN 3852-2 тип X
- Медные прокладки используются только с фитингами типа BS.

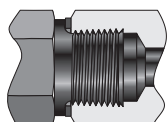

3. Уплотнение манометрических резьб медными кольцами

- Медные прокладки используются только с фитингами типа BS.

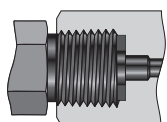

4. Уплотнение позиционируемой резьбы

- Внешнее уплотнение по стандарту DIN 3852-2 тип X

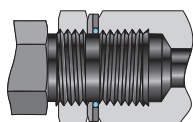

Штуцер с внешней резьбой

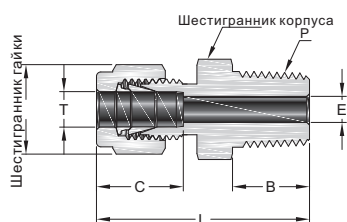

Дюймовая трубка

Резьба NPT

Трубка, дюйм	Резьба P-NPT	Артикул для заказа	Габариты, мм					
			L	B	C	E	G	F
1/16	1/16	F1-MC-NPT1-	23.9	9.7	8.6	1.3	7.9	7.9
1/16	1/8	F1-MC-NPT2-	26.2	9.7	8.6	1.3	7.9	11.1
1/16	1/4	F1-MC-NPT4-	31.0	14.2	8.6	1.3	7.9	14.3
1/8	1/16	F2-MC-NPT1-	29.7	9.7	12.7	2.3	11.1	11.1
1/8	1/8	F2-MC-NPT2-	30.5	9.7	12.7	2.3	11.1	11.1
1/8	1/4	F2-MC-NPT4-	35.6	14.2	12.7	2.3	11.1	14.3
1/8	3/8	F2-MC-NPT6-	35.8	14.2	12.7	2.3	11.1	17.5
1/8	1/2	F2-MC-NPT8-	42.2	19.1	12.7	2.3	11.1	22.2
3/16	1/16	F3-MC-NPT1-	31.2	9.7	13.7	2.3	12.7	11.1
3/16	1/8	F3-MC-NPT2-	31.2	9.7	13.7	3.0	12.7	11.1
3/16	1/4	F3-MC-NPT4-	36.3	14.2	13.7	3.0	12.7	14.3
1/4	1/16	F4-MC-NPT1-	32.8	9.7	15.2	3.0	14.3	12.7
1/4	1/8	F4-MC-NPT2-	32.8	9.7	15.2	4.8	14.3	12.7
1/4	1/4	F4-MC-NPT4-	37.8	14.2	15.2	4.8	14.3	14.3
1/4	3/8	F4-MC-NPT6-	38.4	14.2	15.2	4.8	14.3	17.5
1/4	1/2	F4-MC-NPT8-	44.7	19.1	15.2	4.8	14.3	22.2
1/4	3/4	F4-MC-NPT12-	46.2	19.1	15.2	4.8	14.3	27.0
5/16	1/8	F5-MC-NPT2-	34.0	9.7	16.3	4.8	15.9	14.3
5/16	1/4	F5-MC-NPT4-	38.6	9.7	16.3	6.4	15.9	14.3
5/16	3/8	F5-MC-NPT6-	39.1	14.2	16.3	6.4	15.9	17.5
5/16	1/2	F5-MC-NPT8-	45.5	19.1	16.3	6.4	15.9	22.2
3/8	1/8	F6-MC-NPT2-	35.3	9.7	16.8	4.8	17.5	15.9
3/8	1/4	F6-MC-NPT4-	39.9	14.2	16.8	7.1	17.5	15.9
3/8	3/8	F6-MC-NPT6-	39.9	14.2	16.8	7.1	17.5	17.5
3/8	1/2	F6-MC-NPT8-	46.2	19.1	16.8	7.1	17.5	22.2
3/8	3/4	F6-MC-NPT12-	47.8	19.1	16.8	7.1	17.5	27.0
3/8	1	F6-MC-NPT16-	47.0	23.9	16.8	7.1	17.5	34.9
1/2	1/8	F8-MC-NPT2-	38.9	9.7	22.9	4.8	22.2	20.6
1/2	1/4	F8-MC-NPT4-	43.4	14.2	22.9	7.1	22.2	20.6
1/2	3/8	F8-MC-NPT6-	43.4	14.2	22.9	9.7	22.2	20.6
1/2	1/2	F8-MC-NPT8-	49.0	19.1	22.9	10.4	22.2	22.2
1/2	3/4	F8-MC-NPT12-	50.5	19.1	22.9	10.4	22.2	27.0
1/2	1	F8-MC-NPT16-	57.2	23.9	22.9	10.4	22.2	34.9
5/8	1/4	F10-MC-NPT4-	44.2	14.2	24.4	7.1	25.4	23.8
5/8	3/8	F10-MC-NPT6-	44.2	14.2	24.4	9.7	25.4	23.8
5/8	1/2	F10-MC-NPT8-	49.0	19.1	24.4	11.9	25.4	23.8
5/8	3/4	F10-MC-NPT12-	50.5	19.1	24.4	12.7	25.4	27.0
3/4	3/8	F12-MC-NPT6-	45.7	14.2	24.4	10.4	28.6	27.0
3/4	1/2	F12-MC-NPT8-	50.5	19.1	24.4	11.9	28.6	27.0
3/4	3/4	F12-MC-NPT12-	50.5	19.1	24.4	15.7	28.6	27.0
3/4	1	F12-MC-NPT16-	57.2	23.9	24.4	15.7	28.6	34.9
7/8	1/2	F14-MC-NPT8-	50.5	19.1	25.9	11.9	31.8	30.2
7/8	3/4	F14-MC-NPT12-	50.5	19.1	25.9	15.7	31.8	30.2
7/8	1	F14-MC-NPT16-	57.2	23.9	25.9	18.3	31.8	34.9
1	1/2	F16-MC-NPT8-	57.4	19.1	31.2	11.9	38.1	34.9
1	3/4	F16-MC-NPT12-	57.4	19.1	31.2	15.7	38.1	34.9
1	1	F16-MC-NPT16-	62.2	23.9	31.2	22.4	38.1	34.9
1 1/8	1	F18-MC-NPT16-	62.2	23.9	31.2	22.4	46.0	41.3
1 1/4	1	F20-MC-NPT16-	77.2	23.9	41.1	22.4	47.6	44.5
1 1/4	1 1/4	F20-MC-NPT20-	77.2	23.9	41.1	27.7	47.6	44.5
1 1/2	1 1/2	F24-MC-NPT24-	88.9	26.2	50.0	34.0	57.2	54.0

Штуцер с внешней резьбой

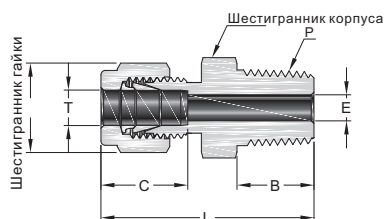

Дюймовая трубка

Коническая резьба ISO (BSPT)

Трубка, дюйм	P-BSPT Резьба	Артикул для заказа	Габариты, мм					
			L	B	C	E	G	F
1/8	1/8	F2-MC-MBT2-	30.5	9.7	12.7	2.3	11.1	11.1
1/8	1/4	F2-MC-MBT4-	35.6	14.2	12.7	2.3	11.1	14.3
1/4	1/8	F4-MC-MBT2-	32.8	9.7	15.2	4.8	14.3	12.7
1/4	1/4	F4-MC-MBT4-	37.8	14.2	15.2	4.8	14.3	14.3
1/4	3/8	F4-MC-MBT6-	38.4	14.2	15.2	4.8	14.3	17.5
1/4	1/2	F4-MC-MBT8-	44.7	19.1	15.2	4.8	14.3	22.2
5/16	1/8	F5-MC-MBT2-	34.0	9.7	16.3	4.8	15.9	14.3
5/16	1/4	F5-MC-MBT4-	38.6	9.7	16.3	6.4	15.9	14.3
3/8	1/8	F6-MC-MBT2-	35.3	9.7	16.8	4.8	17.5	15.9
3/8	1/4	F6-MC-MBT4-	39.9	14.2	16.8	7.1	17.5	15.9
3/8	3/8	F6-MC-MBT6-	39.9	14.2	16.8	7.1	17.5	17.5
3/8	1/2	F6-MC-MBT8-	46.2	19.1	16.8	7.1	17.5	22.2
3/8	3/4	F6-MC-MBT12-	47.8	19.1	16.8	7.1	17.5	27.0
1/2	1/4	F8-MC-MBT4-	43.4	14.2	22.9	7.1	22.2	20.6
1/2	3/8	F8-MC-MBT6-	43.4	14.2	22.9	9.7	22.2	20.6
1/2	1/2	F8-MC-MBT8-	49.0	19.1	22.9	10.4	22.2	22.2
1/2	3/4	F8-MC-MBT12-	50.5	19.1	22.9	10.4	22.2	27.0
5/8	1/2	F10-MC-MBT8-	49.0	19.1	24.4	11.9	25.4	23.8
3/4	3/4	F12-MC-MBT12-	50.5	19.1	24.4	15.7	28.6	27.0
3/4	1	F12-MC-MBT16-	57.2	23.9	24.4	15.7	28.6	34.9
1	3/4	F16-MC-MBT12-	57.4	19.1	31.2	15.7	38.1	34.9
1	1	F16-MC-MBT16-	62.2	23.9	31.2	22.4	38.1	34.9

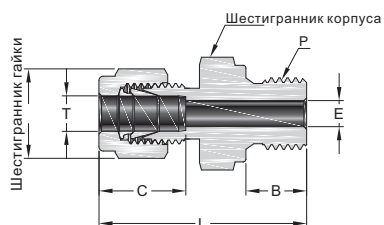

Дюймовая трубка

Цилиндрическая резьба ISO (тип BS)

Трубка, дюйм	P-BS Резьба	Артикул для заказа	Габариты, мм						
			L	B	C	E	G	F	D
1/8	1/8	F2-MC-MBS2-	30.0	7.1	12.7	2.3	11.1	14.3	13.7
1/8	1/4	F2-MC-MBS4-	35.3	11.2	12.7	2.3	11.1	19.1	18.0
1/8	3/8	F2-MC-MBS6-	36.3	11.2	12.7	2.3	11.1	22.2	21.8
1/4	1/8	F4-MC-MBS2-	32.3	7.1	15.2	4.0	14.3	14.3	13.7
1/4	1/4	F4-MC-MBS4-	37.6	11.2	15.2	4.8	14.3	19.1	18.0
1/4	3/8	F4-MC-MBS6-	38.9	11.2	15.2	4.8	14.3	22.2	21.8
1/4	1/2	F4-MC-MBS8-	44.7	14.2	15.2	4.8	14.3	27.0	25.9
3/8	1/8	F6-MC-MBS2-	37.8	7.1	16.8	4.0	17.5	15.9	13.7
3/8	1/4	F6-MC-MBS4-	39.1	11.2	16.8	5.9	17.5	19.1	18.0
3/8	3/8	F6-MC-MBS6-	40.4	11.2	16.8	7.1	17.5	22.2	21.8
3/8	1/2	F6-MC-MBS8-	46.2	14.2	16.8	7.1	17.5	27.0	25.9
1/2	1/4	F8-MC-MBS4-	42.7	11.2	22.9	5.9	22.2	20.6	18.0
1/2	3/8	F8-MC-MBS6-	43.2	11.2	22.9	7.9	22.2	22.2	21.8
1/2	1/2	F8-MC-MBS8-	49.0	14.2	22.9	10.4	22.2	27.0	25.9
3/4	1/2	F12-MC-MBS8-	49.0	14.2	24.4	11.9	28.6	27.0	25.9
3/4	3/4	F12-MC-MBS12-	52.9	15.7	24.4	15.7	28.6	33.3	32.0
1	1/2	F16-MC-MBS8-	55.5	14.2	31.2	11.9	38.1	34.9	25.9
1	3/4	F16-MC-MBS12-	57.7	15.7	31.2	16.0	38.1	34.9	32.0
1	1	F16-MC-MBS16-	59.9	18.3	31.2	19.8	38.1	41.3	39.1

Штуцер с внешней резьбой

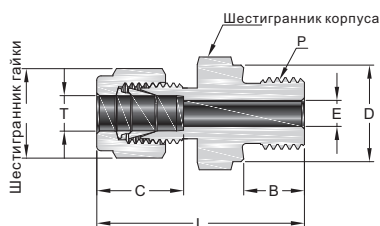

Дюймовая трубка

Цилиндрическая резьба ISO (Тип BP)

Трубка, дюйм	P-BP Резьба	Артикул для заказа	Габариты, мм						
			L	B	C	E	G	F	D
1/8	1/8	F2-MC-PMBP2-	30.0	7.1	12.7	2.3	11.1	14.3	13.7
1/8	1/4	F2-MC-PMBP4-	35.3	11.2	12.7	2.3	11.1	19.1	18.0
1/4	1/8	F4-MC-PMBP2-	32.3	7.1	15.2	4.1	14.3	14.3	13.8
1/4	1/4	F4-MC-PMBP4-	37.6	11.2	15.2	4.8	14.3	19.1	18.0
1/2	3/8	F8-MC-PMBP6-	40.4	11.2	22.9	7.9	22.2	22.2	21.8
1/2	1/2	F8-MC-PMBP8-	49.0	14.2	22.9	10.4	22.2	27.0	25.9
3/4	1/2	F12-MC-PMBP8-	49.0	14.2	24.4	11.9	28.6	27.0	25.9
3/4	3/4	F12-MC-PMBP12-	52.9	15.7	24.4	15.7	28.6	33.3	32
1	1	F16-MC-PMBP16-	59.9	18.3	31.2	19.8	38.1	41.3	39.1

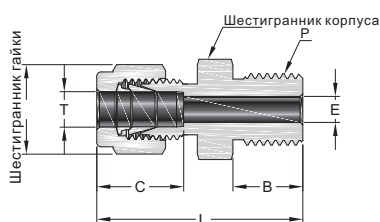

Дюймовая трубка

Цилиндрическая резьба ISO (тип BG)

Трубка, дюйм	P-BG Резьба	Артикул для заказа	Габариты, мм					
			L	B	C	E	G	F
1/4	3/8	F4-MC-MBP6-	38.4	14.2	15.2	4.8	14.3	17.5
3/8	3/8	F6-MC-MBP6-	39.9	14.2	16.8	7.1	17.5	17.5

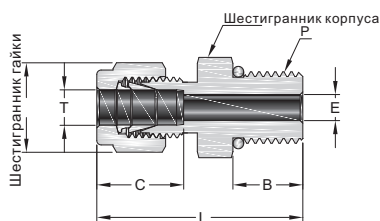

Дюймовая трубка

Прямая резьба SAE/MS

Трубка, дюйм	P-SAE/MS Размер резьбы	Артикул для заказа	Габариты, мм					
			L	B	C	E	G	F
1/16	5/16-24	F1-MC-OST5-	23.4	7.6	8.6	1.3	7.9	11.1
1/8	5/16-24	F2-MC-OST5-	30.0	7.6	12.7	2.3	11.1	11.1
1/8	7/16-20	F2-MC-OST7-	31.5	9.1	12.7	2.3	11.1	14.3
1/8	9/16-18	F2-MC-OST9-	33.3	9.9	12.7	2.3	11.1	17.5
3/16	3/8-24	F3-MC-OST6-	30.5	7.6	13.7	3.0	12.7	12.7
1/4	5/16-24	F4-MC-OST5-	32.3	7.6	15.2	2.3	14.3	12.7
1/4	7/16-20	F4-MC-OST7-	34.0	9.1	15.2	4.8	14.3	14.3
1/4	9/16-18	F4-MC-OST9-	35.6	9.9	15.2	4.8	14.3	17.5
1/4	3/4-16	F4-MC-OST12-	37.6	11.2	15.2	4.8	14.3	22.2
1/4	7/8-14	F4-MC-OST14-	40.6	12.7	15.2	4.8	15.9	25.4
5/16	1/2-20	F5-MC-OST8-	34.8	9.1	16.3	6.4	17.5	15.9
3/8	7/16-20	F6-MC-OST7-	35.6	9.1	16.8	5.1	17.5	15.9
3/8	9/16-18	F6-MC-OST9-	37.1	9.9	16.8	7.1	17.5	17.5
3/8	3/4-16	F6-MC-OST12-	39.1	11.2	16.8	7.1	17.5	22.2
3/8	7/8-14	F6-MC-OST14-	42.2	12.7	22.9	7.1	17.5	25.4
1/2	9/16-18	F8-MC-OST9-	39.1	9.9	22.9	7.1	22.2	20.6
1/2	3/4-16	F8-MC-OST12-	41.9	11.2	22.9	10.4	22.2	22.2
1/2	7/8-14	F8-MC-OST14-	45.0	12.7	22.9	10.4	22.2	25.4
1/2	1 1/16-12	F8-MC-OST17-	49.0	15.0	22.9	10.4	22.2	31.8
5/8	3/4-16	F10-MC-OST12-	41.9	11.2	24.4	10.7	25.4	23.8
5/8	7/8-14	F10-MC-OST14-	45.2	12.7	24.4	12.7	25.4	25.4
3/4	3/4-16	F12-MC-OST12-	46.0	11.2	24.4	10.7	28.6	27.0
3/4	1 1/16-12	F12-MC-OST17-	49.0	15.0	24.4	15.7	28.6	31.8
3/4	1 5/16-12	F12-MC-OST21-	49.8	15.0	24.4	16.0	28.6	38.1
7/8	1 3/16-12	F14-MC-OST19-	49.0	15.0	25.9	18.3	31.8	34.9
1	1 1/16-12	F16-MC-OST17-	53.3	15.0	31.2	16.8	38.1	34.9
1	1 5/16-12	F16-MC-OST21-	54.4	15.0	31.2	22.4	38.1	38.1
1 1/4	1 5/8-12	F20-MC-OST26-	68.3	15.0	41.1	27.7	47.6	47.6
1 1/2	1 7/8-12	F24-MC-OST30-	77.7	15.0	50.0	34.0	57.2	54.0

Изготовлена по стандартам
SAE J1926-1, ISO 11926-1 и MS 16142

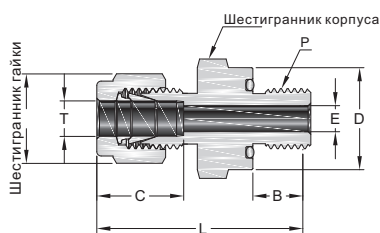
Дюймовая трубка
O-Seal with SAE/MS Прямая резьба

Трубка, дюйм	P-SAE/MS Размер резьбы	Артикул для заказа	Габариты, мм						
			L	B	C	E	G	F	D
1/16	5/16-24	F1-MC-STO5-	26.7	8.6	8.6	1.3	7.9	14.3	14.0
1/8	5/16-24	F2-MC-STO5-	32.8	8.6	12.7	2.3	11.1	14.3	14.0
3/16	3/8-24	F3-MC-STO6-	34.3	9.7	13.7	3.0	12.7	15.9	15.7
1/4	7/16-20	F4-MC-STO7-	38.4	10.4	15.2	4.8	14.3	19.1	18.8
5/16	1/2-20	F5-MC-STO8-	40.6	11.2	16.3	6.4	15.9	22.2	21.8
3/8	9/16-18	F6-MC-STO9-	42.4	11.9	16.8	7.1	17.5	23.8	23.6
1/2	3/4-16	F8-MC-STO12-	46.0	11.9	22.9	10.4	22.2	28.6	28.4
3/4	1 1/16-12	F12-MC-STO17-	52.3	14.2	24.4	15.7	28.6	38.1	37.8
1	1 5/16-12	F16-MC-STO21-	58.2	14.2	31.2	22.4	38.1	44.5	44.2

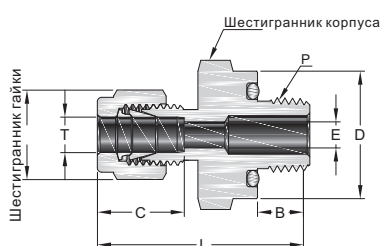

Дюймовая трубка
O-Seal with NPT Thread

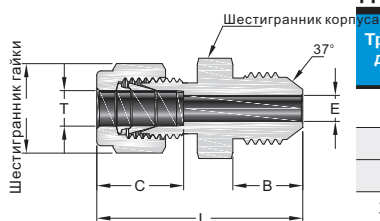
Трубка, дюйм	P-NPT Резьба	Артикул для заказа	Габариты, мм						
			L	B	C	E	G	F	D
1/8	1/8	F2-MC-NPT02-	32.8	7.1	8.6	2.3	11.1	19.1	18.8
1/4	1/8	F4-MC-NPT02-	35.1	7.1	15.2	4.8	14.3	19.1	18.8
1/4	1/4	F4-MC-NPT04-	38.4	9.7	15.2	4.8	14.3	23.8	23.6
3/8	1/4	F6-MC-NPT04-	39.9	9.7	16.8	7.1	17.5	23.8	23.6
3/8	3/8	F6-MC-NPT06-	41.4	10.4	16.8	7.1	17.5	28.6	28.4
3/8	1/2	F6-MC-NPT08-	47.0	13.5	16.8	7.1	17.5	33.3	33.0
1/2	1/2	F8-MC-NPT08-	49.8	13.5	22.9	10.4	22.2	33.3	33.0

Дюймовая трубка
37° Flare (AN)

Трубка, дюйм	AN Tube Flare Size	Артикул для заказа	Габариты, мм						
			L	B	C	E	G	F	
1/16	1/8	F1-MC-AN2-	1.07(27.2)	0.45(11.4)	0.34(8.6)	0.05(1.3)	0.31(7.9)	0.44(11.1)	
1/8	1/8	F2-MC-AN2-	1.27(32.3)	0.45(11.4)	0.50(12.7)	0.06(1.5)	0.44(11.1)	0.44(11.1)	
1/8	1/4	F2-MC-AN4-	1.38(35.1)	0.55(14.0)	0.50(12.7)	0.09(2.3)	0.44(11.1)	0.50(12.7)	
3/16	3/16	F3-MC-AN3-	1.32(33.5)	0.48(12.2)	0.54(13.7)	0.09(2.3)	0.50(12.7)	0.44(11.1)	
1/4	1/4	F4-MC-AN4-	1.48(37.6)	0.55(14.0)	0.60(15.2)	0.17(4.3)	0.56(14.3)	0.50(12.7)	
5/16	5/16	F5-MC-AN5-	1.51(38.4)	0.55(14.0)	0.64(16.2)	0.23(5.8)	0.63(15.9)	0.56(14.3)	
3/8	1/4	F6-MC-AN4-	1.56(39.6)	0.55(14.0)	0.66(16.8)	0.17(4.3)	0.69(17.5)	0.63(15.9)	
3/8	3/8	F6-MC-AN6-	1.56(39.6)	0.56(14.1)	0.66(16.8)	0.28(7.1)	0.69(17.5)	0.63(15.9)	
1/2	1/2	F8-MC-AN8-	1.81(46.0)	0.66(16.7)	0.90(22.8)	0.39(9.9)	0.87(22.2)	0.81(20.6)	
5/8	5/8	F10-MC-AN10-	1.93(49.0)	0.76(19.3)	0.96(24.5)	0.48(12.3)	1.00(25.4)	0.94(23.8)	
3/4	3/4	F12-MC-AN12-	2.10(53.3)	0.86(21.9)	0.96(24.4)	0.61(15.5)	1.13(28.6)	1.13(28.6)	
1	1	F16-MC-AN16-	2.42(61.5)	0.91(23.1)	1.23(31.2)	0.84(21.3)	1.50(38.1)	1.37(34.9)	

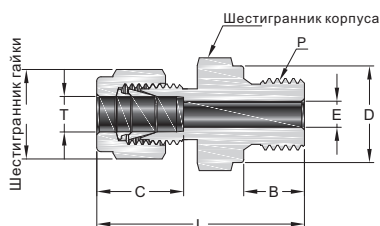
Штуцер с внешней резьбой



Дюймовая трубка метрическая резьба (BSMS)

Трубка, дюйм	Р-Метрический Размер резьбы	Артикул для заказа	Габариты, мм						
			L	B	C	E	G	F	D
1/8	M14x1.5	F2-MC-BSMS14-	36.7	12	12.7	2.3	11.1	19.1	19
1/8	M16x1.5	F2-MC-BSMS16-	37.5	12	12.7	2.3	11.1	22.2	21
1/8	M18x1.5	F2-MC-BSMS18-	38.5	12	12.7	2.3	11.1	23.8	23
1/8	M20x1.5	F2-MC-BSMS20-	41.1	14	12.7	2.3	11.1	25.4	25
1/4	M14x1.5	F4-MC-BSMS14-	38.0	12	15.2	4.8	14.3	19.1	19
1/4	M16x1.5	F4-MC-BSMS16-	39.9	12	15.2	4.8	14.3	22.2	21
1/4	M18x1.5	F4-MC-BSMS18-	40.8	12	15.2	4.8	14.3	23.8	23
1/4	M20x1.5	F4-MC-BSMS20-	43.6	14	15.2	4.8	14.3	25.4	25
3/8	M14x1.5	F6-MC-BSMS14-	41.3	12	16.8	7.1	17.5	19.1	19
3/8	M16x1.5	F6-MC-BSMS16-	41.3	12	16.8	7.1	17.5	22.2	21
3/8	M18x1.5	F6-MC-BSMS18-	41.8	12	16.8	7.1	17.5	23.8	23
3/8	M20x1.5	F6-MC-BSMS20-	45.1	14	16.8	7.1	17.5	25.4	25
1/2	M16x1.5	F8-MC-BSMS16-	44.0	12	22.9	9.0	22.2	22.2	21
1/2	M18x1.5	F8-MC-BSMS18-	44.0	12	22.9	10.0	22.2	23.8	23
1/2	M20x1.5	F8-MC-BSMS20-	47.9	14	22.9	10.4	22.2	25.4	25
1/2	M22x1.5	F8-MC-BSMS22-	48.5	14	22.9	10.4	22.2	27.0	27

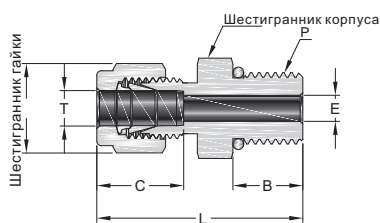

Adapt to straight thread boss of ISO 6149-1.

Дюймовая трубка метрическая резьба (OMS)

Трубка, дюйм	Р-Метрический Размер резьбы	Артикул для заказа	Габариты, мм					
			L	B	C	E	G	F
1/4	M14X1.5	F4-MC-OMS14-	35.2	11	15.2	4.8	14.3	19.1
3/8	M14X1.5	F6-MC-OMS14-	36.7	11	16.8	7.1	17.5	19.1
3/8	M20X1.5	F6-MC-OMS20-	41.2	14	16.8	7.1	17.5	27.0
1/2	M14X1.5	F8-MC-OMS14-	40.2	11	22.9	7.5	22.2	20.6
1/2	M20X1.5	F8-MC-OMS20-	44.0	14	22.9	10.4	22.2	27.0

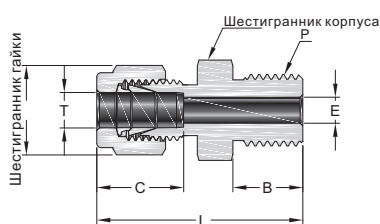

Дюймовая трубка метрическая резьба (MS)

Трубка, дюйм	Р-Метрический Размер резьбы	Артикул для заказа	Габариты, мм					
			L	B	C	E	G	F
1/16	M5x0.8	F1-MC-MS5-	21.8	8	8.6	1.3	7.9	7.9
1/8	M14x1.5	F2-MC-MS14-	34.8	13	12.7	2.3	11.1	15.9
1/8	M16x1.5	F2-MC-MS16-	35.8	14	12.7	2.3	11.1	17.5
1/8	M18x1.5	F2-MC-MS18-	37.2	15	12.7	2.3	11.1	19.1
1/8	M20x1.5	F2-MC-MS20-	38.2	16	12.7	2.3	11.1	22.2
1/4	M14x1.5	F4-MC-MS14-	36.9	13	15.2	4.8	14.3	15.9
1/4	M16x1.5	F4-MC-MS16-	38.1	14	15.2	4.8	14.3	17.5
1/4	M18x1.5	F4-MC-MS18-	39.5	15	15.2	4.8	14.3	19.1
1/4	M20x1.5	F4-MC-MS20-	40.7	16	15.2	4.8	14.3	22.2
3/8	M10x1.0	F4-MC-MS10-	36.4	11	16.8	4.8	17.5	15.9
3/8	M14x1.5	F6-MC-MS14-	39.3	13	16.8	7.1	17.5	15.9
3/8	M16X1.5	F6-MC-MS16-	39.7	14	16.8	7.1	17.5	17.5
3/8	M18x1.5	F6-MC-MS18-	41.5	15	16.8	7.1	17.5	19.1
3/8	M20x1.5	F6-MC-MS20-	42.3	16	16.8	7.1	17.5	22.2
1/2	M16x1.5	F8-MC-MS16-	43.2	14	22.9	8.4	22.2	20.6
1/2	M18x1.5	F8-MC-MS18-	43.7	15	22.9	9.6	22.2	20.6
1/2	M20x1.5	F8-MC-MS20-	44.9	16	22.9	10.4	22.2	22.2
1/2	M22x1.5	F8-MC-MS22-	47.0	17	22.9	10.4	22.2	23.8

Штуцер с внешней резьбой

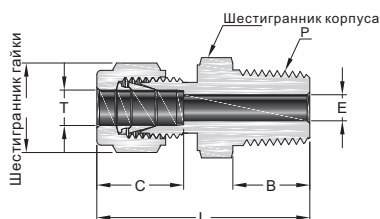

Метрическая трубка

NPT Резьба

Трубка, дюйм	P-NPT Резьба	Артикул для заказа	Габариты, мм					
			L	B	C	E	G	F
2	1/8	M2-MC-NPT2-	30.5	9.7	12.9	1.7	12	12
3	1/8	M3-MC-NPT2-	30.5	9.7	12.9	2.4	12	12
3	1/4	M3-MC-NPT4-	35.6	14.2	12.9	2.4	12	14
4	1/8	M4-MC-NPT2-	31.2	9.7	13.7	2.4	12	12
4	1/4	M4-MC-NPT4-	36.3	14.2	13.7	2.4	12	14
6	1/8	M6-MC-NPT2-	32.8	9.7	15.3	4.8	14	14
6	1/4	M6-MC-NPT4-	37.9	14.2	15.3	4.8	14	14
6	3/8	M6-MC-NPT6-	38.4	14.2	15.3	4.8	14	18
6	1/2	M6-MC-NPT8-	44.7	19.1	15.3	4.8	14	22
8	1/8	M8-MC-NPT2-	34.2	9.7	16.2	4.8	16	15
8	1/4	M8-MC-NPT4-	38.7	14.2	16.2	6.4	16	15
8	3/8	M8-MC-NPT6-	39.3	14.2	16.2	6.4	16	18
8	1/2	M8-MC-NPT8-	45.6	19.1	16.2	6.4	16	22
10	1/8	M10-MC-NPT2-	36.3	9.7	17.2	4.8	19	18
10	1/4	M10-MC-NPT4-	40.9	14.2	17.2	7.1	19	18
10	3/8	M10-MC-NPT6-	40.9	14.2	17.2	7.9	19	18
10	1/2	M10-MC-NPT8-	46.5	19.1	17.2	7.9	19	22
10	3/4	M10-MC-NPT12-	48.0	19.1	17.2	7.9	19	27
10	1	M10-MC-NPT16-	54.6	23.9	17.2	7.9	19	35
12	1/8	M12-MC-NPT2-	38.8	9.7	22.8	4.8	22	22
12	1/4	M12-MC-NPT4-	43.4	14.2	22.8	7.1	22	22
12	3/8	M12-MC-NPT6-	43.4	14.2	22.8	9.5	22	22
12	1/2	M12-MC-NPT8-	49.0	19.1	22.8	9.5	22	22
12	3/4	M12-MC-NPT12-	50.5	19.1	22.8	9.5	22	27
14	1/8	M14-MC-NPT2-	38.8	9.7	24.4	4.8	25	24
14	1/4	M14-MC-NPT4-	44.1	14.2	24.4	7.1	25	24
14	3/8	M14-MC-NPT6-	44.1	14.2	24.4	9.5	25	24
14	1/2	M14-MC-NPT8-	49.0	19.1	24.4	11.1	25	24
14	3/4	M14-MC-NPT12-	50.5	19.1	24.4	11.1	25	27
15	1/2	M15-MC-NPT8-	49.0	19.1	24.4	11.9	25	24
15	3/4	M15-MC-NPT12-	50.5	19.1	24.4	11.9	25	27
15	1	M15-MC-NPT16-	57.1	23.9	24.4	11.9	25	35
16	1/4	M16-MC-NPT4-	44.1	14.2	24.4	7.1	25	24
16	3/8	M16-MC-NPT6-	44.1	14.2	24.4	9.5	25	24
16	1/2	M16-MC-NPT8-	49.0	19.1	24.4	11.9	25	24
16	3/4	M16-MC-NPT12-	50.5	19.1	24.4	12.7	25	27
18	3/8	M18-MC-NPT6-	45.6	14.2	24.4	9.5	30	27
18	1/2	M18-MC-NPT8-	50.5	19.1	24.4	11.9	30	27
18	3/4	M18-MC-NPT12-	50.5	19.1	24.4	15.1	30	27
20	1/2	M20-MC-NPT8-	52.3	19.1	26.0	11.9	32	30
20	3/4	M20-MC-NPT12-	52.3	19.1	26.0	15.9	32	30
20	1	M20-MC-NPT16-	57.1	23.9	26.0	15.9	32	35
22	1/2	M22-MC-NPT8-	52.3	19.1	26.0	11.9	32	30
22	3/4	M22-MC-NPT12-	52.3	19.1	26.0	15.9	32	30
22	1	M22-MC-NPT16-	57.1	23.9	26.0	18.3	32	35
25	1/2	M25-MC-NPT8-	57.5	19.1	31.3	11.9	38	35
25	3/4	M25-MC-NPT12-	57.5	19.1	31.3	15.9	38	35
25	1	M25-MC-NPT16-	62.3	23.9	31.3	21.8	38	35
28	1	M28-MC-NPT16-	72.4	23.9	36.6	21.8	46	41
28	1 1/4	M28-MC-NPT20-	73.1	23.9	36.6	21.8	46	46
30	1 1/4	M30-MC-NPT20-	77.2	23.9	39.6	26.2	50	46
32	1 1/4	M32-MC-NPT20-	79.6	23.9	42.0	28.6	50	46
38	1 1/2	M38-MC-NPT24-	91.6	26.2	49.4	33.7	60	55

Штуцер с внешней резьбой

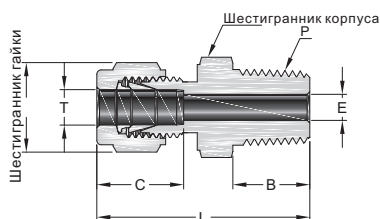

Метрическая трубка

ISO Коническая резьба (BSPT)

Трубка, мм	P-BSPT Резьба	Артикул для заказа	Габариты, мм					
			L	B	C	E	G	F
2	1/8	M2-MC-MBT2-	30.5	9.7	12.9	1.7	12	12
3	1/8	M3-MC-MBT2-	30.5	9.7	12.9	2.4	12	12
3	1/4	M3-MC-MBT4-	35.6	14.2	12.9	2.4	12	14
4	1/8	M4-MC-MBT2-	31.2	9.7	13.7	2.4	12	12
4	1/4	M4-MC-MBT4-	36.3	14.2	13.7	2.4	12	14
6	1/8	M6-MC-MBT2-	32.8	9.7	15.3	4.8	14	14
6	1/4	M6-MC-MBT4-	37.9	14.2	15.3	4.8	14	14
6	3/8	M6-MC-MBT6-	38.4	14.2	15.3	4.8	14	18
6	1/2	M6-MC-MBT8-	44.7	19.1	15.3	4.8	14	22
8	1/8	M8-MC-MBT2-	34.2	9.7	16.2	4.8	16	15
8	1/4	M8-MC-MBT4-	38.7	14.2	16.2	6.4	16	15
8	3/8	M8-MC-MBT6-	39.2	14.2	16.2	6.4	16	18
8	1/2	M8-MC-MBT8-	45.6	19.1	16.2	6.4	16	22
10	1/8	M10-MC-MBT2-	36.3	9.7	17.2	4.8	19	18
10	1/4	M10-MC-MBT4-	40.9	14.2	17.2	7.1	19	18
10	3/8	M10-MC-MBT6-	40.9	14.2	17.2	7.9	19	18
10	1/2	M10-MC-MBT8-	46.5	19.1	17.2	7.9	19	22
10	3/4	M10-MC-MBT12-	48.0	19.1	17.2	7.9	19	27
12	1/8	M12-MC-MBT2-	38.3	9.7	22.8	4.8	22	22
12	1/4	M12-MC-MBT4-	43.4	14.2	22.8	7.1	22	22
12	3/8	M12-MC-MBT6-	43.4	14.2	22.8	9.5	22	22
12	1/2	M12-MC-MBT8-	49.0	19.1	22.8	9.5	22	22
12	3/4	M12-MC-MBT12-	50.5	19.1	22.8	9.5	22	27
14	1/8	M14-MC-MBT2-	38.8	9.7	24.4	4.8	25	24
14	1/4	M14-MC-MBT4-	44.1	14.2	24.4	7.1	25	24
14	3/8	M14-MC-MBT6-	44.1	14.2	24.4	7.9	25	24
14	1/2	M14-MC-MBT8-	49.0	19.1	24.4	11.1	25	24
14	3/4	M14-MC-MBT12-	50.5	19.1	24.4	11.1	25	27
15	1/2	M15-MC-MBT8-	49.0	19.1	24.4	11.9	25	24
16	1/4	M16-MC-MBT4-	44.1	14.2	24.4	7.1	25	24
16	3/8	M16-MC-MBT6-	44.1	14.2	24.4	9.5	25	24
16	1/2	M16-MC-MBT8-	49.0	19.1	24.4	11.9	25	24
16	3/4	M16-MC-MBT12-	50.5	19.1	24.4	12.7	25	27
18	1/2	M18-MC-MBT8-	50.5	19.1	24.4	11.9	30	27
18	3/4	M18-MC-MBT12-	50.5	19.1	24.4	15.1	30	27
20	1/2	M20-MC-MBT8-	52.3	19.1	26.0	11.9	32	30
20	3/4	M20-MC-MBT12-	52.3	19.1	26.0	15.9	32	30
22	3/4	M22-MC-MBT12-	52.3	19.1	26.0	15.9	32	30
22	1	M22-MC-MBT16-	57.1	23.9	26.0	18.3	32	35
25	1/2	M25-MC-MBT8-	57.5	19.1	31.3	11.9	38	35
25	3/4	M25-MC-MBT12-	57.5	19.1	31.3	15.9	38	35
25	1	M25-MC-MBT16-	62.3	23.9	31.3	21.8	38	35
28	1	M28-MC-MBT16-	72.4	23.9	36.6	21.8	46	41
28	1 1/4	M28-MC-MBT20-	73.1	23.9	36.6	21.8	46	46
30	1 1/4	M30-MC-MBT20-	77.2	23.9	39.6	26.2	50	46
32	1 1/4	M32-MC-MBT20-	79.6	23.9	42.0	28.6	50	46
38	1 1/2	M38-MC-MBT24-	91.6	26.2	49.4	33.7	60	55

Штуцер с внешней резьбой

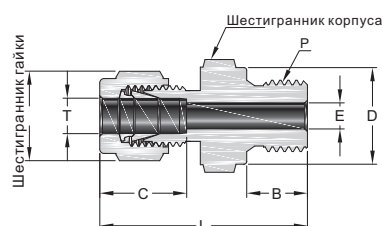

Метрическая трубка

ISO Цилиндрическая резьба (BS)

Трубка, мм	P-BS Резьба	Артикул для заказа	Габариты, мм						
			L	B	C	E	G	F	D
2	1/8	M2-MC-MBS2-	30.0	7.1	12.9	1.7	12	14	13.7
3	1/8	M3-MC-MBS2-	30.0	7.1	12.9	2.4	12	14	13.7
3	1/4	M3-MC-MBS4-	35.3	11.2	12.9	2.4	12	19	18.0
4	1/8	M4-MC-MBS2-	30.7	7.1	13.7	2.4	12	14	13.7
4	1/4	M4-MC-MBS4-	36.0	11.2	13.7	2.4	12	19	18.0
6	1/8	M6-MC-MBS2-	32.3	7.1	15.3	4.0	14	14	13.7
6	1/4	M6-MC-MBS4-	37.6	11.2	15.3	4.8	14	19	18.0
6	3/8	M6-MC-MBS6-	38.9	11.2	15.3	4.8	14	22	21.6
6	1/2	M6-MC-MBS8-	44.7	14.2	15.3	4.8	14	27	25.9
8	1/8	M8-MC-MBS2-	33.2	7.1	16.2	4.0	16	15	14.5
8	1/4	M8-MC-MBS4-	38.5	11.2	16.2	6.4	16	19	18.0
8	3/8	M8-MC-MBS6-	39.8	11.2	16.2	6.4	16	22	21.6
8	1/2	M8-MC-MBS8-	45.6	14.2	16.2	6.4	16	27	25.9
8	3/4	M8-MC-MBS12-	49.5	15.7	16.2	6.4	16	35	32.0
10	1/4	M10-MC-MBS4-	39.4	11.2	17.2	5.9	19	19	18.0
10	3/8	M10-MC-MBS6-	40.6	11.2	17.2	7.9	19	22	21.6
10	1/2	M10-MC-MBS8-	46.5	14.2	17.2	7.9	19	27	25.9
12	1/4	M12-MC-MBS4-	42.6	11.2	22.8	5.9	22	22	21.6
12	3/8	M12-MC-MBS6-	43.1	11.2	22.8	7.9	22	22	21.6
12	1/2	M12-MC-MBS8-	49.0	14.2	22.8	9.5	22	27	25.9
12	3/4	M12-MC-MBS12-	52.8	15.7	22.8	9.5	22	35	32.0
14	1/4	M14-MC-MBS4-	42.9	11.2	24.4	7.1	25	24	18.0
14	3/8	M14-MC-MBS6-	43.9	11.2	24.4	7.9	25	24	21.6
14	1/2	M14-MC-MBS8-	49.0	14.2	24.4	11.1	25	27	25.9
14	3/4	M14-MC-MBS12-	52.8	15.7	24.4	11.1	25	35	32.0
15	3/8	M15-MC-MBS6-	43.9	11.2	24.4	7.9	25	24	21.6
15	1/2	M15-MC-MBS8-	49.0	14.2	24.4	11.9	25	27	25.9
15	3/4	M15-MC-MBS12-	52.8	15.7	24.4	11.9	25	35	32.0
16	3/8	M16-MC-MBS6-	43.9	11.2	24.4	7.9	25	24	21.6
16	1/2	M16-MC-MBS8-	49.0	14.2	24.4	11.9	25	27	25.9
16	3/4	M16-MC-MBS12-	52.8	15.7	24.4	12.7	25	35	32.0
18	1/2	M18-MC-MBS8-	49.0	14.2	24.4	11.9	30	27	25.9
18	3/4	M18-MC-MBS12-	52.8	15.7	24.4	15.1	30	35	32.0
20	1/2	M20-MC-MBS8-	50.5	14.2	26.0	11.9	32	30	25.9
20	3/4	M20-MC-MBS12-	52.8	15.7	26.0	15.9	32	35	32.0
22	3/4	M22-MC-MBS12-	52.8	15.7	26.0	15.9	32	35	32.0
22	1	M22-MC-MBS16-	55.3	18.3	26.0	18.3	32	41	39.1
25	3/4	M25-MC-MBS12-	57.5	15.7	31.3	15.9	38	35	32.0
25	1	M25-MC-MBS16-	60.1	18.3	31.3	19.8	38	41	39.1
28	1	M28-MC-MBS16-	70.1	18.3	36.6	19.8	46	41	39.1
28	1 1/4	M28-MC-MBS20-	73.9	19.8	36.6	21.8	46	50	49.0
30	1 1/4	M30-MC-MBS20-	76.5	19.8	39.6	25.0	50	50	49.0
32	1 1/4	M32-MC-MBS20-	78.9	19.8	42.0	25.0	50	50	49.0
38	1 1/2	M38-MC-MBS24-	90.8	22.1	49.4	31.8	60	55	54.7

Штуцер с внешней резьбой

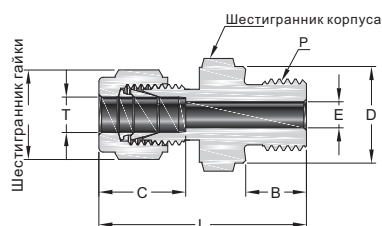

Метрическая трубка

ISO Цилиндрическая резьба (BP)

Трубка, мм	P-BP Резьба	Артикул для заказа	Габариты, мм						
			L	B	C	E	G	F	D
3	1/8	M3-MC-PMBP2-	30.0	7.1	12.9	2.4	12	14	13.8
3	1/4	M3-MC-PMBP4-	35.3	11.2	12.9	2.4	12	19	18.0
4	1/8	M4-MC-PMBP2-	30.7	7.1	13.7	2.4	12	14	13.8
6	1/8	M6-MC-PMBP2-	32.3	7.1	15.3	4.0	14	14	13.8
6	1/4	M6-MC-PMBP4-	37.6	11.2	15.3	4.8	14	19	18.0
6	3/8	M6-MC-PMBP6-	38.9	11.2	15.3	4.8	14	22	21.8
6	1/2	M6-MC-PMBP8-	44.7	14.2	15.3	4.8	14	27	26.0
8	1/8	M8-MC-PMBP2-	33.3	7.1	16.2	4.0	16	15	13.8
8	1/4	M8-MC-PMBP4-	38.5	11.2	16.2	5.9	16	19	18.0
8	3/8	M8-MC-PMBP6-	39.8	11.2	16.2	6.4	16	22	21.8
8	1/2	M8-MC-PMBP8-	45.6	14.2	16.2	6.4	16	27	26.0
10	1/4	M10-MC-PMBP4-	39.4	11.2	17.2	5.9	19	19	18.0
10	3/8	M10-MC-PMBP6-	40.6	11.2	17.2	7.9	19	22	21.8
10	1/2	M10-MC-PMBP8-	46.5	14.2	17.2	7.9	19	27	26.0
12	1/4	M12-MC-PMBP4-	42.6	11.2	22.8	5.9	22	22	18.0
12	3/8	M12-MC-PMBP6-	43.1	11.2	22.8	7.9	22	22	21.8
12	1/2	M12-MC-PMBP8-	49.0	14.2	22.8	9.5	22	27	26.0
12	3/4	M12-MC-PMBP12-	52.8	15.7	22.8	9.5	22	35	32.0
15	1/2	M15-MC-PMBP8-	49.0	14.2	24.4	11.9	25	27	26.0
16	3/8	M16-MC-PMBP6-	43.9	11.2	24.4	7.9	25	24	21.8
16	1/2	M16-MC-PMBP8-	49.0	14.2	24.4	11.9	25	27	26.0
18	1/2	M18-MC-PMBP8-	49.0	14.2	24.4	11.9	30	27	26.0
18	3/4	M18-MC-PMBP12-	52.8	15.7	24.4	15.1	30	35	32.0
20	1/2	M20-MC-PMBP8-	50.5	14.2	26.0	11.9	32	30	26.0
20	3/4	M20-MC-PMBP12-	52.8	15.7	26.0	15.9	32	35	32.0
22	3/4	M22-MC-PMBP12-	52.8	15.7	26.0	15.9	32	35	32.0
22	1	M22-MC-PMBP16-	55.3	18.3	26.0	18.3	32	41	39.0
25	3/4	M25-MC-PMBP12-	57.5	15.7	31.3	15.9	38	35	32.0
25	1	M25-MC-PMBP16-	60.1	18.3	31.3	19.8	38	41	39.0
28	1	M28-MC-PMBP16-	70.1	18.3	36.6	19.8	46	41	39.0
28	1 1/4	M28-MC-PMBP20-	73.9	19.8	36.6	21.8	46	50	49.0
30	1 1/4	M30-MC-PMBP20-	76.5	19.8	39.6	26.2	50	50	49.0
32	1 1/4	M32-MC-PMBP20-	78.9	19.8	42.0	28.6	50	50	49.0
38	1 1/2	M38-MC-PMBP24-	89.3	20.6	49.4	31.8	60	55	54.7

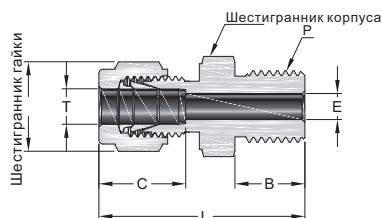

Метрическая трубка

ISO Цилиндрическая резьба (BG)

Трубка, мм	P-BG Резьба	Артикул для заказа	Габариты, мм					
			L	B	C	E	G	F
6	1/4	M6-MC-MBP4-	36.9	12.9	15.3	4.8	14	14
6	3/8	M6-MC-MBP6-	39.5	14.2	15.3	4.8	14	18
8	1/8	M8-MC-MBP2-	33.9	9.8	16.2	4.0	16	14
8	1/4	M8-MC-MBP4-	37.0	12.9	16.2	6.4	16	14
8	3/8	M8-MC-MBP6-	39.3	14.2	16.2	6.4	16	18
8	1/2	M8-MC-MBP8-	45.4	18.8	16.2	6.4	16	22
10	1/4	M10-MC-MBP4-	39.5	12.9	17.2	5.9	19	18
10	1/2	M10-MC-MBP8-	46.3	18.8	17.2	7.9	19	22
12	3/8	M12-MC-MBP6-	44.2	14.2	22.8	7.9	22	22
12	1/2	M12-MC-MBP8-	49.0	18.8	22.8	9.5	22	22
14	1/4	M14-MC-MBP4-	42.9	12.9	24.4	5.9	25	24
16	3/8	M16-MC-MBP6-	43.4	14.2	24.4	7.9	25	24
16	1/2	M16-MC-MBP8-	47.9	18.8	24.4	9.5	25	24
18	1/2	M18-MC-MBP8-	49.8	18.8	24.4	9.5	30	27

Штуцер с внешней резьбой

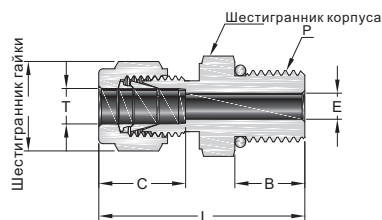

Адаптер по стандартам
SAE J1926-1, ISO 11926-1 и MS 16142

Метрическая трубка

SAE/MS Прямая резьба

Трубка, мм	P-SAE/MS Размер резьбы	Артикул для заказа	Габариты, мм					
			L	B	C	E	G	F
6	9/16-18	M6-MC-OST9-	35.6	9.9	15.3	4.8	14	18
10	9/16-18	M10-MC-OST9-	37.3	9.9	17.2	7.1	19	22
10	3/4-16	M10-MC-OST12-	39.4	11.2	17.2	7.9	19	22
12	7/16-20	M12-MC-OST7-	40.6	9.1	22.8	5.2	22	22
12	9/16-18	M12-MC-OST9-	39.9	9.9	22.8	7.1	22	22

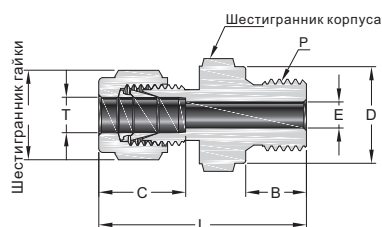

Метрическая трубка

Метрическая резьба (BSMS)

Трубка, мм	P-Метрический Размер резьбы	Артикул для заказа	Габариты, мм						
			L	B	C	E	G	F	D
6	M8 x 1	M6-MC-BSMS8-	33.3	8	15.3	3.0	14	14	12
6	M10 x 1	M6-MC-BSMS10-	36.3	8	15.3	4.0	14	14	14
6	M12 x 1.5	M6-MC-BSMS12-	38.2	12	15.3	4.8	14	18	17
6	M14 x 1.5	M6-MC-BSMS14-	39.7	12	15.3	4.8	14	19	19
8	M8 x 1	M8-MC-BSMS8-	34.1	8	16.2	3.0	16	14	12
8	M10 x 1	M8-MC-BSMS10-	34.1	8	16.2	5.0	16	15	14
8	M12 x 1.5	M8-MC-BSMS12-	40.4	12	16.2	6.0	16	18	17
8	M14 x 1.5	M8-MC-BSMS14-	40.4	12	16.2	6.4	16	19	19
10	M12 x 1.5	M10-MC-BSMS12-	40.7	12	17.2	6.0	19	18	17
10	M14 x 1.5	M10-MC-BSMS14-	41.5	12	17.2	7.9	19	19	19
12	M16 x 1.5	M12-MC-BSMS16-	45.5	12	22.8	9	22	22	21
12	M20 x 1.5	M12-MC-BSMS20-	48.0	14	22.8	9.5	22	25	25
12	M22 x 1.5	M12-MC-BSMS22-	49.5	14	22.8	9.5	22	27	27
14	M14 x 1.5	M14-MC-BSMS14-	44.9	12	24.4	8	25	24	19
14	M20 x 1.5	M14-MC-BSMS20-	48.0	14	24.4	11.1	25	25	25
16	M20 x 1.5	M16-MC-BSMS20-	48.0	14	24.4	12	25	25	25
18	M20 x 1.5	M18-MC-BSMS20-	48.5	14	24.4	12	30	27	25
20	M20 x 1.5	M20-MC-BSMS20-	50.0	14	26.0	12	32	30	25
22	M24 x 1.5	M22-MC-BSMS24-	50.5	14	26.0	15	32	30	29
25	M27 x 2	M25-MC-BSMS27-	57.5	16	31.3	16.8	38	35	32

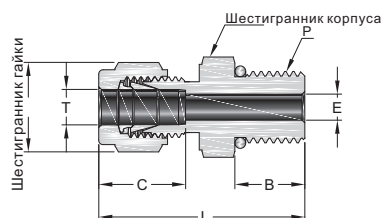

Адаптер по стандарту ISO 6149-1

Метрическая трубка

Метрическая резьба (OMS)

Трубка, мм	P-Метрический Размер резьбы	Артикул для заказа	Габариты, мм					
			L	B	C	E	G	F
6	M14 x 1.5	M6-MC-OMS14-	35.2	11	15.3	4.8	14	19
10	M14 x 1.5	M10-MC-OMS14-	36.7	11	17.2	7.5	19	19
10	M20 x 1.5	M10-MC-OMS20-	41.2	14	17.2	7.9	19	27
12	M14 x 1.5	M12-MC-OMS14-	40.2	11	22.8	7.5	22	22
12	M20 x 1.5	M12-MC-OMS20-	44.0	14	22.8	10.4	22	27

Штуцер с внешней резьбой

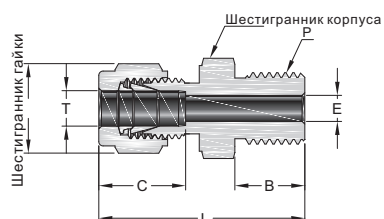

Метрическая трубка

Метрическая резьба (MS)

Трубка, мм	Р-Метрический Размер резьбы	Артикул для заказа	Габариты, мм					
			L	B	C	E	G	F
	M6 x 1	M6-MC-MS6-	32.4	8	15.3	2.0	14	14
6	M8 x 1	M6-MC-MS8-	32.4	9	15.3	3.0	14	14
6	M10 x 1	M6-MC-MS10-	35.2	11	15.3	4.7	14	14
6	M12 x 1.5	M6-MC-MS12-	36.4	12	15.3	4.8	14	14
6	M14 x 1.5	M6-MC-MS14-	37.4	13	15.3	4.8	14	16
6	M16 x 1.5	M6-MC-MS16-	38.4	14	15.3	4.8	14	18
6	M18 x 1.5	M6-MC-MS18-	40.0	15	15.3	4.8	14	19
6	M20 x 1.5	M6-MC-MS20-	41.7	16	15.3	4.8	14	22
8	M8 x 1	M8-MC-MS8-	34.5	9	16.2	3.0	16	14
8	M10 x 1	M8-MC-MS10-	35.6	11	16.2	4.7	16	14
8	M12 x 1.5	M8-MC-MS12-	36.6	12	16.2	6.0	16	14
8	M14 x 1.5	M8-MC-MS14-	37.7	13	16.2	6.4	16	16
8	M20 x 1.5	M8-MC-MS20-	42.5	16	16.2	6.4	16	22
10	M12 x 1.5	M10-MC-MS12-	38.7	12	17.2	6.0	19	18
10	M14 x 1.5	M10-MC-MS14-	39.7	13	17.2	7.2	19	18
10	M20 x 1.5	M10-MC-MS20-	43.5	16	17.2	7.9	19	22
12	M12 x 1.5	M12-MC-MS12-	41.2	12	22.8	6.0	22	22
12	M16 x 1.5	M12-MC-MS16-	43.2	14	22.8	9.5	22	22
12	M18 x 1.5	M12-MC-MS18-	44.2	15	22.8	9.5	22	22
12	M20 x 1.5	M12-MC-MS20-	45.2	16	22.8	9.5	22	22
14	M14 x 1.5	M14-MC-MS14-	42.5	13	24.4	7.2	25	24
14	M16 x 1.5	M14-MC-MS16-	43.9	14	24.4	8.4	25	24
14	M20 x 1.5	M14-MC-MS20-	45.1	16	24.4	10.8	25	24
16	M20 x 1.5	M16-MC-MS20-	46.1	16	24.4	10.8	25	24
18	M20 x 1.5	M18-MC-MS20-	47.5	16	24.4	10.8	30	27
18	M22 x 1.5	M18-MC-MS22-	48.5	17	24.4	12	30	27
20	M20 x 1.5	M20-MC-MS20-	49.5	16	26.0	10.8	32	30
22	M24 x 1.5	M22-MC-MS24-	50.5	17	26.0	14.4	32	30
25	M27 x 2	M22-MC-MS27-	57.0	18	31.3	16.1	38	35

Штуцер с внешней резьбой и монтажом на панель

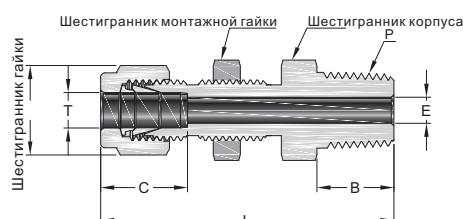

Дюймовая трубка

NPT Резьба

Трубка, мм	P-NPT Резьба	Артикул для заказа	Габариты, мм							Panel Hole Size (mm)	Max. Panel Thickness (mm)
			L	B	C	E	G	F	Gx		
1/16	1/16	F1-BMC-NPT1-	30.2	9.7	8.6	1.3	7.9	7.9	7.9	5.2	6.4
1/16	1/8	F1-BMC-NPT2-	32.3	9.7	8.6	1.3	7.9	11.1	7.9	5.2	6.4
1/8	1/8	F2-BMC-NPT2-	46.5	9.7	12.7	2.3	11.1	12.7	12.7	8.3	12.7
3/16	1/8	F3-BMC-NPT2-	48.0	9.7	13.7	3.0	12.7	14.3	14.3	9.9	12.7
1/4	1/8	F4-BMC-NPT2-	49.5	9.7	15.2	4.8	14.3	15.9	15.9	11.5	10.2
1/4	1/4	F4-BMC-NPT4-	54.1	14.2	15.2	4.8	14.3	15.9	15.9	11.5	10.2
1/4	3/8	F4-BMC-NPT6-	54.9	14.2	15.2	4.8	14.3	17.5	15.9	11.5	10.2
1/4	1/2	F4-BMC-NPT8-	60.3	19.1	15.2	4.8	14.3	22.2	15.9	11.5	10.2
5/16	1/8	F5-BMC-NPT2-	52.8	9.7	16.3	4.8	15.9	17.5	17.5	13.1	11.2
5/16	1/4	F5-BMC-NPT4-	57.7	14.2	16.3	6.4	15.9	17.5	17.5	13.1	11.2
3/8	1/8	F6-BMC-NPT2-	52.9	9.7	16.8	4.8	17.5	19.1	19.1	14.7	11.2
3/8	1/4	F6-BMC-NPT4-	57.4	14.2	16.8	7.1	17.5	19.1	19.1	14.7	11.2
3/8	3/8	F6-BMC-NPT6-	57.4	14.2	16.8	7.1	17.5	19.1	19.1	14.7	11.2
3/8	1/2	F6-BMC-NPT8-	63.8	19.1	16.8	7.1	17.5	22.2	19.1	14.7	11.2
1/2	1/8	F8-BMC-NPT2-	58.7	9.7	22.9	4.8	22.2	23.8	23.8	19.4	12.7
1/2	1/4	F8-BMC-NPT4-	63.2	14.2	22.9	7.1	22.2	23.8	23.8	19.4	12.7
1/2	3/8	F8-BMC-NPT6-	63.2	14.2	22.9	9.7	22.2	23.8	23.8	19.4	12.7
1/2	1/2	F8-BMC-NPT8-	68.8	19.1	22.9	10.4	22.2	23.8	23.8	19.4	12.7
5/8	3/8	F10-BMC-NPT6-	66.7	14.2	24.4	9.7	25.4	27.0	27.0	22.6	15.1
5/8	1/2	F10-BMC-NPT8-	71.5	19.1	24.4	11.9	25.4	27.0	27.0	22.6	15.1
3/4	1/2	F12-BMC-NPT8-	76.2	19.1	24.4	11.9	28.6	30.2	30.2	25.8	16.8
3/4	3/4	F12-BMC-NPT12-	76.2	19.1	24.4	15.7	28.6	30.2	30.2	25.8	16.8
7/8	3/4	F14-BMC-NPT12-	84.1	19.1	25.9	15.7	31.8	33.3	33.3	29.0	19.1
1	3/4	F16-BMC-NPT12-	88.4	19.1	31.2	15.7	38.1	41.3	41.3	33.7	19.1
1	1	F16-BMC-NPT16-	93.2	23.9	31.2	22.4	38.1	41.3	41.3	33.7	19.1

Метрическая трубка

NPT Резьба

Трубка, мм	P-NPT Резьба	Артикул для заказа	Габариты, мм							Panel Hole Size (mm)	Max. Panel Thickness (mm)
			L	B	C	E	G	F	Gx		
6	1/8	M6-BMC-NPT2-	49.6	9.7	15.3	4.8	14	16	16	11.5	10.2
6	1/4	M6-BMC-NPT4-	53.6	14.2	15.3	4.8	14	16	16	11.5	10.2
8	1/8	M8-BMC-NPT2-	52.3	9.7	16.2	4.8	16	18	18	13.1	11.2
8	1/4	M8-BMC-NPT4-	57.5	14.2	16.2	6.4	16	18	18	13.1	11.2
10	1/4	M10-BMC-NPT4-	58.4	14.2	17.2	7.9	19	22	22	16.3	11.2
10	3/8	M10-BMC-NPT6-	58.4	14.2	17.2	7.9	19	22	22	16.3	11.2
10	1/2	M10-BMC-NPT8-	63.1	19.1	17.2	7.9	19	22	22	16.3	11.2
12	1/4	M12-BMC-NPT4-	63.9	14.2	22.8	7.9	22	24	24	19.5	12.7
12	3/8	M12-BMC-NPT6-	63.9	14.2	22.8	9.5	22	24	24	19.5	12.7
12	1/2	M12-BMC-NPT8-	68.8	19.1	22.8	9.5	22	24	24	19.5	12.7

Штуцер с внешней резьбой и монтажом на панель

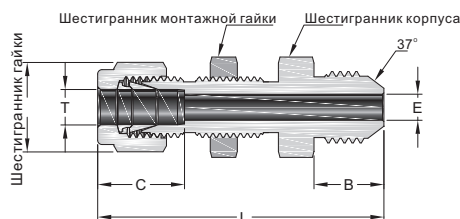

Дюймовая трубка

AN резьба 37°

Трубка, дюйм	AN Tube Flare Size	Артикул для заказа	Габариты, мм							Panel Hole Size in. (mm)	Max. Panel Thickness in. (mm)
			L	B	C	E	G	F	Gx		
1/8	1/8	F2-BMC-AN2-	1.91 (48.5)	0.45 (11.4)	0.50 (12.7)	0.06 (1.5)	0.44 (11.1)	0.50 (12.7)	0.50 (12.7)	0.33 (8.3)	0.50 (12.7)
1/8	1/4	F2-BMC-AN4-	2.04 (51.8)	0.55 (14.0)	0.50 (12.7)	0.09 (2.3)	0.44 (11.1)	0.63 (15.9)	0.50 (12.7)	0.33 (8.3)	0.51 (12.7)
3/16	3/16	F3-BMC-AN3-	1.98 (50.3)	0.48 (12.2)	0.54 (13.7)	0.09 (2.3)	0.50 (12.7)	0.56 (14.3)	0.56 (14.3)	0.39 (9.9)	0.50 (12.7)
1/4	1/4	F4-BMC-AN4-	2.12 (53.8)	0.55 (14.0)	0.60 (15.2)	0.17 (4.3)	0.56 (14.3)	0.63 (15.9)	0.63 (15.9)	0.45 (11.5)	0.40 (10.2)
5/16	5/16	F5-BMC-AN5-	2.21 (56.1)	0.55 (14.0)	0.64 (16.2)	0.23 (5.8)	0.63 (15.9)	0.69 (17.5)	0.69 (17.5)	0.52 (13.1)	0.56 (14.3)
3/8	1/4	F6-BMC-AN4-	2.25 (57.2)	0.55 (14.0)	0.66 (16.8)	0.17 (4.3)	0.69 (17.5)	0.75 (19.1)	0.75 (19.1)	0.58 (14.7)	0.44 (11.2)
3/8	3/8	F6-BMC-AN6-	2.25 (57.2)	0.56 (14.2)	0.66 (16.8)	0.28 (7.1)	0.69 (17.5)	0.75 (19.1)	0.75 (19.1)	0.58 (14.7)	0.44 (11.2)
1/2	1/2	F8-BMC-AN8-	2.59 (65.8)	0.66 (16.8)	0.90 (22.8)	0.39 (9.9)	0.87 (22.2)	0.94 (23.8)	0.94 (23.8)	0.76 (19.4)	0.50 (12.7)
5/8	5/8	F10-BMC-AN10-	2.74 (69.6)	0.76 (19.3)	0.96 (24.4)	0.48 (12.3)	1.00 (25.4)	1.06 (27.0)	1.06 (27.0)	0.89 (22.6)	0.59 (15.1)
3/4	3/4	F12-BMC-AN12-	3.11 (79.0)	0.86 (21.8)	0.96 (24.4)	0.61 (15.5)	1.13 (28.6)	1.19 (30.2)	1.19 (30.2)	1.02 (25.8)	0.66 (16.8)
1	1	F16-BMC-AN16-	3.64 (92.5)	0.91 (23.1)	1.23 (31.2)	0.84 (21.3)	1.50 (38.1)	1.63 (41.3)	1.63 (41.3)	1.33 (33.7)	0.75 (19.1)

Фитинги для подключения терморпар(со сквозным проходом трубки)

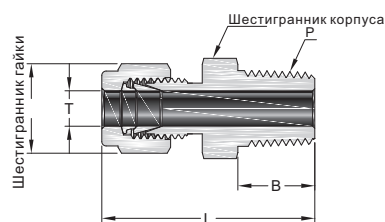

Дюймовая трубка

NPT Резьба

Трубка, дюйм	P-NPT Резьба	Артикул для заказа	Габариты, мм			
			L	B	G	F
1/16	1/16	F1-TC-NPT1-	23.9	9.7	7.9	7.9
1/16	1/8	F1-TC-NPT2-	26.2	9.7	7.9	11.1
1/16	1/4	F1-TC-NPT4-	31.0	14.2	7.9	14.3
1/8	1/16	F2-TC-NPT1-	29.7	9.7	11.1	11.1
1/8	1/8	F2-TC-NPT2-	30.5	9.7	11.1	11.1
1/8	1/4	F2-TC-NPT4-	35.6	14.2	11.1	14.3
3/16	1/8	F3-TC-NPT2-	31.2	9.7	12.7	11.1
3/16	1/4	F3-TC-NPT4-	36.3	14.2	12.7	14.3
1/4	1/8	F4-TC-NPT2-	32.8	9.7	14.3	12.7
1/4	1/4	F4-TC-NPT4-	37.8	14.2	14.3	14.3
1/4	3/8	F4-TC-NPT6-	38.4	14.2	14.3	17.5
1/4	1/2	F4-TC-NPT8-	44.7	19.1	14.3	22.2
5/16	1/4	F5-TC-NPT4-	38.6	14.2	15.9	14.3
3/8	1/4	F6-TC-NPT4-	39.9	14.2	17.5	15.9
3/8	3/8	F6-TC-NPT6-	39.9	14.2	17.5	17.5
3/8	1/2	F6-TC-NPT8-	46.2	19.1	17.5	22.2
3/8	3/4	F6-TC-NPT12-	47.8	19.1	17.5	27.0
1/2	1/2	F8-TC-NPT8-	49.0	19.1	22.2	22.2
1/2	3/4	F8-TC-NPT12-	50.5	19.1	22.2	27.0
5/8	3/4	F10-TC-NPT12-	50.5	19.1	25.4	27.0
3/4	3/4	F12-TC-NPT12-	50.5	19.1	28.6	27.0
1	1	F16-TC-NPT16-	62.2	23.9	38.1	34.9

Фитинги с внешней резьбой для термопар

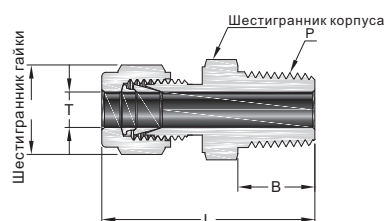

Метрическая трубка

NPT Резьба

Трубка, мм	P-NPT Резьба	Артикул для заказа	Габариты, мм			
			L	B	G	F
2	1/8	M2-TC-NPT2-	30.5	9.7	12	12
3	1/8	M3-TC-NPT2-	30.5	9.7	12	12
3	1/4	M3-TC-NPT4-	35.6	14.2	12	14
4	1/8	M4-TC-NPT2-	31.2	9.7	12	12
4	1/4	M4-TC-NPT4-	36.3	14.2	12	14
6	1/8	M6-TC-NPT2-	32.8	9.7	14	14
6	1/4	M6-TC-NPT4-	37.9	14.2	14	14
6	3/8	M6-TC-NPT6-	38.4	14.2	14	18
6	1/2	M6-TC-NPT8-	44.7	19.1	14	22
8	1/4	M8-TC-NPT4-	38.7	14.2	16	15
8	3/8	M8-TC-NPT6-	39.3	14.2	16	18
8	1/2	M8-TC-NPT8-	45.6	19.1	16	22
10	3/8	M10-TC-NPT6-	40.9	14.2	19	18
10	1/2	M10-TC-NPT8-	46.5	19.1	19	22
10	3/4	M10-TC-NPT12-	48.0	19.1	19	27
10	1	M10-TC-NPT16-	54.6	23.9	19	35
12	3/8	M12-TC-NPT6-	43.4	14.2	22	22
12	1/2	M12-TC-NPT8-	49.0	19.1	22	22
12	3/4	M12-TC-NPT12-	50.5	19.1	22	27
14	1/2	M14-TC-NPT8-	49.0	19.1	25	24
14	3/4	M14-TC-NPT12-	50.5	19.1	25	27
15	1/2	M15-TC-NPT8-	49.0	19.1	25	24
15	3/4	M15-TC-NPT12-	50.5	19.1	25	27
15	1	M15-TC-NPT16-	57.1	23.9	25	35
16	3/4	M16-TC-NPT12-	50.5	19.1	25	27
18	3/4	M18-TC-NPT12-	50.5	19.1	30	27
20	1	M20-TC-NPT16-	57.1	23.9	32	35
22	1	M22-TC-NPT16-	57.1	23.9	32	35
25	1	M25-TC-NPT16-	62.3	23.9	38	35

Фитинг с внутренней резьбой

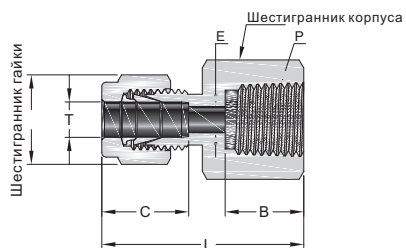

Дюймовая трубка

NPT Резьба

Трубка, дюйм	P-NPT Резьба	Артикул для заказа	Габариты, мм					
			L	B	C	E	G	F
1/16	1/16	F1-FC-FNPT1-	23.6	9.9	8.6	1.3	7.9	11.1
1/16	1/8	F1-FC-FNPT2-	24.4	10.4	8.6	1.3	7.9	14.3
1/8	1/8	F2-FC-FNPT2-	28.7	10.4	12.7	2.3	11.1	14.3
1/8	1/4	F2-FC-FNPT4-	33.5	15.0	12.7	2.3	11.1	19.1
3/16	1/8	F3-FC-FNPT2-	29.7	10.4	13.7	3.0	12.7	14.3
1/4	1/8	F4-FC-FNPT2-	31.2	10.4	15.2	4.8	14.3	14.3
1/4	1/4	F4-FC-FNPT4-	35.8	15.0	15.2	4.8	14.3	19.1
1/4	3/8	F4-FC-FNPT6-	37.6	15.0	15.2	4.8	14.3	22.2
1/4	1/2	F4-FC-FNPT8-	42.4	19.8	15.2	4.8	14.3	27.0
5/16	1/8	F5-FC-FNPT2-	32.0	10.4	16.3	6.4	15.9	14.3
5/16	1/4	F5-FC-FNPT4-	36.8	15.0	16.3	6.4	15.9	19.1
3/8	1/8	F6-FC-FNPT2-	32.8	10.4	16.8	7.1	17.5	15.9
3/8	1/4	F6-FC-FNPT4-	37.6	15.0	16.8	7.1	17.5	19.1
3/8	3/8	F6-FC-FNPT6-	39.1	15.0	16.8	7.1	17.5	22.2
3/8	1/2	F6-FC-FNPT8-	43.9	19.8	16.8	7.1	17.5	27.0
3/8	3/4	F6-FC-FNPT12-	47.8	20.6	16.8	7.1	17.5	33.3
1/2	1/4	F8-FC-FNPT4-	40.4	15.0	22.9	10.4	22.2	20.6
1/2	3/8	F8-FC-FNPT6-	41.9	15.0	22.9	10.4	22.2	22.2
1/2	1/2	F8-FC-FNPT8-	46.7	19.8	22.9	10.4	22.2	27.0
1/2	3/4	F8-FC-FNPT12-	48.3	20.6	22.9	10.4	22.2	33.3
5/8	3/8	F10-FC-FNPT6-	41.9	15.0	24.4	12.7	25.4	23.8
5/8	1/2	F10-FC-FNPT8-	46.7	19.8	24.4	12.7	25.4	27.0
3/4	1/2	F12-FC-FNPT8-	46.7	19.8	24.4	15.7	28.6	27.0
3/4	3/4	F12-FC-FNPT12-	48.3	20.6	24.4	15.7	28.6	33.3
7/8	3/4	F14-FC-FNPT12-	49.8	20.6	25.9	18.3	31.8	33.3
1	3/4	F16-FC-FNPT12-	53.3	20.6	31.2	22.4	38.1	34.9
1	1	F16-FC-FNPT16-	62.2	25.4	31.2	22.4	38.1	41.3
1 1/4	1 1/4	F20-FC-FNPT20-	74.7	25.4	41.1	27.7	47.6	54.0
1 1/2	1 1/2	F24-FC-FNPT24-	83.3	27.7	50.0	36.3	57.2	60.3

Дюймовая трубка

ISO Коническая резьба (BSPT)

Трубка, дюйм	P-BSPT Резьба	Артикул для заказа	Габариты, мм					
			L	B	C	E	G	F
1/4	1/8	F4-FC-FBT2-	31.2	10.4	15.2	4.8	14.3	14.3
1/4	1/4	F4-FC-FBT4-	35.8	15.0	15.2	4.8	14.3	19.1
1/4	3/8	F4-FC-FBT6-	37.6	15.0	15.2	4.8	14.3	22.2
1/4	1/2	F4-FC-FBT8-	42.4	19.8	15.2	4.8	14.3	27.0
3/8	1/4	F6-FC-FBT4-	37.6	15.0	16.8	7.1	17.5	19.1
3/8	3/8	F6-FC-FBT6-	39.1	15.0	16.8	7.1	17.5	22.2
3/8	1/2	F6-FC-FBT8-	43.9	19.8	16.8	7.1	17.5	27.0
1/2	1/4	F8-FC-FBT4-	40.4	15.0	22.9	10.4	22.2	20.6
1/2	3/8	F8-FC-FBT6-	41.9	15.0	22.9	10.4	22.2	22.2
1/2	1/2	F8-FC-FBT8-	46.7	19.8	22.9	10.4	22.2	27.0

Фитинг с внутренней резьбой

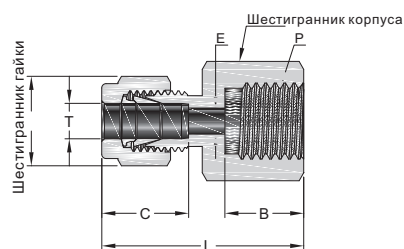

Дюймовая трубка

ISO Цилиндрическая резьба (BG)

Трубка, дюйм	P-BG Резьба	Артикул для заказа	Габариты, мм					
			L	B	C	E	G	F
1/8	1/4	F2-FC-FBP4-	35.3	12.9	12.7	2.3	11.1	19.1
1/8	3/8	F2-FC-FBP6-	38.7	14.2	12.7	2.3	11.1	23.8
1/4	1/4	F4-FC-FBP4-	37.6	12.9	15.2	4.8	14.3	19.1
1/4	3/8	F4-FC-FBP6-	37.6	14.2	15.2	4.8	14.3	23.8
1/4	1/2	F4-FC-FBP8-	43.4	18.8	15.2	4.8	14.3	27.0
5/16	1/4	F5-FC-FBP4-	38.4	12.9	16.3	5.6	15.9	19.1
5/16	3/8	F5-FC-FBP6-	39.2	14.2	16.3	6.4	15.9	23.8
5/16	1/2	F5-FC-FBP8-	40.9	18.8	16.3	7.1	15.9	27.0
3/8	1/4	F6-FC-FBP4-	39.1	12.9	16.8	5.6	17.5	19.1
3/8	3/8	F6-FC-FBP6-	38.6	14.2	16.8	6.4	17.5	23.8
3/8	1/2	F6-FC-FBP8-	41.9	18.8	16.8	7.1	17.5	27.0
1/2	1/4	F8-FC-FBP4-	41.9	12.9	22.9	5.6	22.2	22.2
1/2	3/8	F8-FC-FBP6-	44.5	14.2	22.9	6.4	22.2	23.8
1/2	1/2	F8-FC-FBP8-	48.3	18.8	22.9	7.1	22.2	27.0

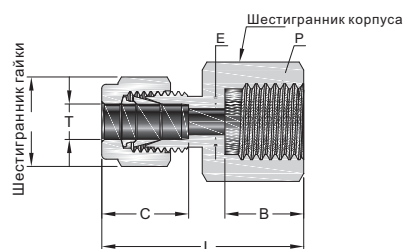

Дюймовая трубка

Метрическая резьба

Трубка, дюйм	P-Метрический Размер резьбы	Артикул для заказа	Габариты, мм					
			L	B	C	E	G	F
1/8	M14 x 1.5	F2-FC-FMS14-	32.3	13	12.7	2.3	11.1	19.1
1/8	M16 x 1.5	F2-FC-FMS16-	33.3	14	12.7	2.3	11.1	22.2
1/8	M18 x 1.5	F2-FC-FMS18-	34.3	15	12.7	2.3	11.1	25.4
1/8	M20 x 1.5	F2-FC-FMS20-	35.3	16	12.7	2.3	11.1	27.0
1/4	M16 x 1.5	F4-FC-FMS16-	35.8	14	15.2	4.8	14.3	22.2
1/4	M18 x 1.5	F4-FC-FMS18-	36.8	15	15.2	4.8	14.3	25.4
1/4	M20 x 1.5	F4-FC-FMS20-	37.8	16	15.2	4.8	14.3	27.0
3/8	M14 x 1.5	F6-FC-FMS14-	37.1	13	16.8	7.1	17.5	19.1
3/8	M16 x 1.5	F6-FC-FMS16-	37.5	14	16.8	7.1	17.5	22.2
3/8	M18 x 1.5	F6-FC-FMS18-	38.5	15	16.8	7.1	17.5	25.4
3/8	M20 x 1.5	F6-FC-FMS20-	39.5	16	16.8	7.1	17.5	27.0
1/2	M16 x 1.5	F8-FC-FMS16-	41.4	14	22.9	8.4	22.2	22.2
1/2	M18 x 1.5	F8-FC-FMS18-	42.4	15	22.9	9.6	22.2	25.4
1/2	M20 x 1.5	F8-FC-FMS20-	43.4	16	22.9	10.4	22.2	27.0
1/2	M22 x 1.5	F8-FC-FMS22-	44.4	17	22.9	10.4	22.2	27.0

Фитинг с внутренней резьбой

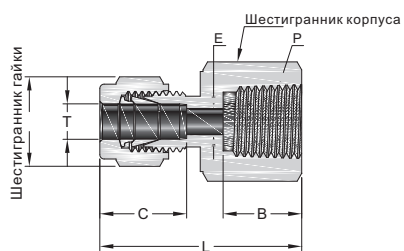

Метрическая трубка

NPT Резьба

Трубка, мм	R-NPT Резьба	Артикул для заказа	Габариты, мм					
			L	B	C	E	G	F
3	1/8	M3-FC-FNPT2-	28.7	10.4	12.9	2.4	12	14
3	1/4	M3-FC-FNPT4-	33.5	15.0	12.9	2.4	12	19
4	1/8	M4-FC-FNPT2-	29.7	10.4	13.7	2.4	12	14
6	1/8	M6-FC-FNPT2-	31.3	10.4	15.3	4.8	14	14
6	1/4	M6-FC-FNPT4-	35.8	15.0	15.3	4.8	14	19
6	3/8	M6-FC-FNPT6-	37.7	15.0	15.3	4.8	14	22
6	1/2	M6-FC-FNPT8-	42.5	19.8	15.3	4.8	14	27
8	1/8	M8-FC-FNPT2-	32.1	10.4	16.2	4.8	16	15
8	1/4	M8-FC-FNPT4-	37.0	15.0	16.2	6.4	16	19
8	3/8	M8-FC-FNPT6-	38.5	15.0	16.2	6.4	16	22
8	1/2	M8-FC-FNPT8-	43.3	19.8	16.2	6.4	16	27
10	1/8	M10-FC-FNPT2-	33.0	10.4	17.2	4.8	19	15
10	1/4	M10-FC-FNPT4-	37.8	15.0	17.2	7.9	19	19
10	3/8	M10-FC-FNPT6-	39.4	15.0	17.2	7.9	19	22
10	1/2	M10-FC-FNPT8-	44.2	19.8	17.2	7.9	19	27
12	1/4	M12-FC-FNPT4-	40.3	15.0	22.8	7.9	22	22
12	3/8	M12-FC-FNPT6-	41.9	15.0	22.8	9.5	22	22
12	1/2	M12-FC-FNPT8-	46.7	19.8	22.8	9.5	22	27
12	3/4	M12-FC-FNPT12-	49.7	20.6	22.8	9.5	22	35
14	3/4	M14-FC-FNPT12-	49.7	20.6	24.4	11.1	25	35
15	1/2	M15-FC-FNPT8-	46.7	19.8	24.4	11.9	25	27
16	3/8	M16-FC-FNPT6-	41.9	15.0	24.4	9.5	25	27
16	1/2	M16-FC-FNPT8-	46.9	19.8	24.4	11.9	25	27
20	1/2	M20-FC-FNPT8-	47.9	19.8	26.0	11.9	32	30
20	3/4	M20-FC-FNPT12-	49.7	20.6	26.0	15.9	32	35
22	3/4	M22-FC-FNPT12-	49.7	20.6	26.0	15.9	32	35
22	1	M22-FC-FNPT16-	57.9	25.4	26.0	18.3	32	41
25	3/4	M25-FC-FNPT12-	53.4	20.6	31.3	15.9	38	35
25	1	M25-FC-FNPT16-	62.3	25.4	31.3	21.8	38	41

Фитинг с внутренней резьбой

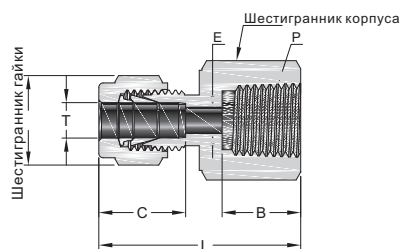

Метрическая трубка

ISO Коническая резьба (BSPT)

Трубка, мм	P-BSPT Резьба	Артикул для заказа	Габариты, мм					
			L	B	C	E	G	F
3	1/8	M3-FC-FBT2-	28.7	10.4	12.9	2.4	12	14
6	1/8	M6-FC-FBT2-	31.3	10.4	15.3	4.8	14	14
6	1/4	M6-FC-FBT4-	35.8	15.0	15.3	4.8	14	19
6	3/8	M6-FC-FBT6-	36.9	15.0	15.3	4.8	14	22
6	1/2	M6-FC-FBT8-	42.5	19.8	15.3	4.8	14	27
8	1/8	M8-FC-FBT2-	32.1	10.4	16.2	6.4	16	15
8	1/4	M8-FC-FBT4-	37.0	15.0	16.2	6.4	16	19
8	3/8	M8-FC-FBT6-	38.5	15.0	16.2	6.4	16	22
8	1/2	M8-FC-FBT8-	43.3	19.8	16.2	6.4	16	27
10	1/8	M10-FC-FBT2-	33.0	10.4	17.2	7.9	19	18
10	1/4	M10-FC-FBT4-	37.8	15.0	17.2	7.9	19	19
10	3/8	M10-FC-FBT6-	39.4	15.0	17.2	7.9	19	22
10	1/2	M10-FC-FBT8-	44.2	19.8	17.2	7.9	19	27
12	1/8	M12-FC-FBT2-	35.5	10.4	22.8	8.3	22	22
12	1/4	M12-FC-FBT4-	40.3	15.0	22.8	9.5	22	22
12	3/8	M12-FC-FBT6-	41.9	15.0	22.8	9.5	22	22
12	1/2	M12-FC-FBT8-	46.7	19.8	22.8	9.5	22	27
12	3/4	M12-FC-FBT12-	49.0	20.6	22.8	9.5	22	35
15	1/2	M15-FC-FBT8-	46.7	19.8	24.4	11.9	25	27
16	1/2	M16-FC-FBT8-	48.4	19.8	24.4	11.9	25	27
16	3/4	M16-FC-FBT12-	49.7	20.6	24.4	12.7	25	35
20	1/2	M20-FC-FBT8-	47.9	19.8	26.0	11.9	32	30
20	3/4	M20-FC-FBT12-	49.7	20.6	26.0	15.9	32	35
22	3/4	M22-FC-FBT12-	49.7	20.6	26.0	15.9	32	35
22	1	M22-FC-FBT16-	57.9	25.4	26.0	18.3	32	41
25	3/4	M25-FC-FBT12-	53.4	20.6	31.3	15.9	38	35
25	1	M25-FC-FBT16-	62.3	25.4	31.3	21.8	38	41

Фитинг с внутренней резьбой

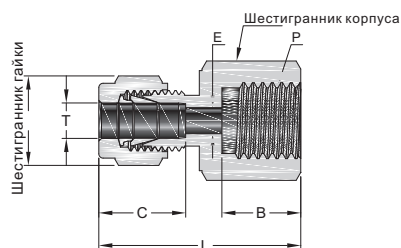

Метрическая трубка

ISO Цилиндрическая резьба (BG)

Трубка, мм	P-BG Резьба	Артикул для заказа	Габариты, мм					
			L	B	C	E	G	F
3	1/4	M3-FC-FBP4-	35.3	12.9	12.9	2.4	12	19
6	1/4	M6-FC-FBP4-	37.6	12.9	15.3	4.8	14	19
6	3/8	M6-FC-FBP6-	37.6	14.2	15.3	4.8	14	24
6	1/2	M6-FC-FBP8-	43.5	18.8	15.3	4.8	14	27
8	1/4	M8-FC-FBP4-	38.5	12.9	16.2	6.4	16	19
8	3/8	M8-FC-FBP6-	36.2	14.2	16.2	6.4	16	24
8	1/2	M8-FC-FBP8-	41.0	18.8	16.2	6.4	16	27
10	1/4	M10-FC-FBP4-	39.4	12.9	17.2	5.9	19	19
10	3/8	M10-FC-FBP6-	38.8	14.2	17.2	7.9	19	24
10	1/2	M10-FC-FBP8-	42.1	18.8	17.2	7.9	19	27
12	1/4	M12-FC-FBP4-	41.9	12.9	22.8	5.9	22	22
12	3/8	M12-FC-FBP6-	44.4	14.2	22.8	7.9	22	24
12	1/2	M12-FC-FBP8-	48.2	18.8	22.8	9.5	22	27
20	1/2	M20-FC-FBP8-	54.3	18.8	26.0	11.9	32	30
22	1/2	M22-FC-FBP8-	54.3	18.8	26.0	11.9	32	30

Метрическая трубка

Метрическая резьба

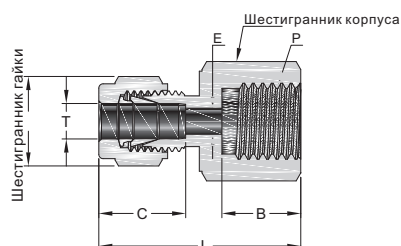

Трубка, мм	P-Метрический Размер резьбы	Артикул для заказа	Габариты, мм					
			L	B	C	E	G	F
6	M10 x 1	M6-FC-FMS10-	32.7	11	15.3	4.0	14	16
6	M14 x 1.5	M6-FC-FMS14-	34.7	13	15.3	4.8	14	19
6	M20 x 1.5	M6-FC-FMS20-	37.7	16	15.3	4.8	14	27
8	M8 x 1	M8-FC-FMS8-	31.6	9	16.2	3.2	16	14
8	M10 x 1	M8-FC-FMS10-	33.6	11	16.2	4.0	16	16
8	M14 x 1.5	M8-FC-FMS14-	35.6	13	16.2	6.0	16	19
8	M20 x 1.5	M8-FC-FMS20-	38.6	16	16.2	6.4	16	27
10	M16 x 1.5	M10-FC-FMS16-	38.1	14	17.2	7.9	19	22
12	M20 x 1.5	M12-FC-FMS20-	44.9	16	22.8	9.5	22	27
14	M10 x 1	M14-FC-FMS10-	42.5	11	24.4	4.0	25	24
14	M20 x 1.5	M14-FC-FMS20-	44.9	16	24.4	10.8	25	27
14	M22 x 1.5	M14-FC-FMS22-	45.9	17	24.4	11.1	25	27
16	M20 x 1.5	M16-FC-FMS20-	44.9	16	24.4	10.8	26	27
20	M20 x 1.5	M20-FC-FMS20-	46.5	16	26.0	10.8	32	30
25	M27 x 2	M25-FC-FMS27-	54.4	18	31.3	16.1	38	35

Фитинг с внутренней резьбой с креплением на панель

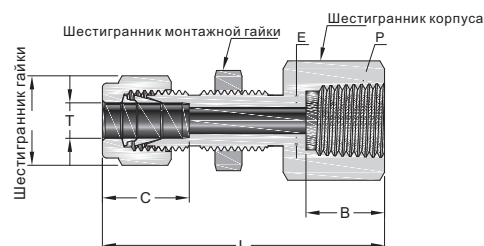

Дюймовая трубка

NPT Резьба

Трубка, дюйм	P-NPT Резьба	Артикул для заказа	Габариты, мм							Panel Hole Size (mm)	Max. Panel Thickness (mm)
			L	B	C	E	G	F	Gx		
1/16	1/16	F1-BFC-FNPT1-	26.2	9.9	8.6	1.3	7.9	11.1	7.9	5.2	3.2
1/16	1/8	F1-BFC-FNPT2-	26.9	10.4	8.6	1.3	7.9	14.3	7.9	5.2	3.2
1/8	1/8	F2-BFC-FNPT2-	44.7	10.4	12.7	2.3	11.1	14.3	12.7	8.3	12.7
1/8	1/4	F2-BFC-FNPT4-	49.6	15.0	12.7	2.3	11.1	19.1	12.7	8.3	12.7
3/16	1/8	F3-BFC-FNPT2-	45.5	10.4	13.7	3.0	12.7	14.3	14.3	9.9	12.7
1/4	1/8	F4-BFC-FNPT2-	47.0	10.4	15.2	4.8	14.3	15.9	15.9	11.5	10.2
1/4	1/4	F4-BFC-FNPT4-	51.8	15.0	15.2	4.8	14.3	19.1	15.9	11.5	10.2
1/4	3/8	F4-BFC-FNPT6-	53.3	15.0	15.2	4.8	14.3	22.2	15.9	11.5	10.2
1/4	1/2	F4-BFC-FNPT8-	58.2	19.8	15.2	4.8	14.3	27.0	15.9	11.5	10.2
5/16	1/8	F5-BFC-FNPT2-	49.8	10.4	16.3	6.4	15.9	14.3	17.5	13.1	11.2
5/16	1/4	F5-BFC-FNPT4-	60.5	15.0	16.3	6.4	15.9	19.1	17.5	13.1	11.2
3/8	1/8	F6-BFC-FNPT2-	50.3	10.4	16.8	7.1	17.5	15.9	19.1	14.5	11.2
3/8	1/4	F6-BFC-FNPT4-	55.1	15.0	16.8	7.1	17.5	19.1	19.1	14.5	11.2
3/8	3/8	F6-BFC-FNPT6-	56.6	15.0	16.8	7.1	17.5	22.2	19.1	14.5	11.2
3/8	1/2	F6-BFC-FNPT8-	61.5	19.8	16.8	7.1	17.5	27.0	19.1	14.5	11.2
3/8	3/4	F6-BFC-FNPT12-	65.3	20.6	16.8	7.1	17.5	33.3	19.1	14.5	11.2
1/2	1/4	F8-BFC-FNPT4-	60.2	15.0	22.9	10.4	22.2	23.8	23.8	19.4	12.7
1/2	3/8	F8-BFC-FNPT6-	61.7	15.0	22.9	10.4	22.2	23.8	23.8	19.4	12.7
1/2	1/2	F8-BFC-FNPT8-	66.5	19.8	22.9	10.4	22.2	27.0	23.8	19.4	12.7
1/2	3/4	F8-BFC-FNPT12-	68.1	20.6	22.9	10.4	22.2	33.3	23.8	19.4	12.7
5/8	3/8	F10-BFC-FNPT6-	62.5	15.0	24.4	12.7	25.4	23.8	27.0	22.6	15.1
5/8	1/2	F10-BFC-FNPT8-	67.3	19.8	24.4	12.7	25.4	27.0	27.0	22.6	15.1
3/4	1/2	F12-BFC-FNPT8-	72.2	19.8	24.4	15.7	28.6	27.0	30.2	25.8	19.8
3/4	3/4	F12-BFC-FNPT12-	73.7	20.6	24.4	15.7	28.6	33.3	30.2	25.8	19.8
7/8	3/4	F14-BFC-FNPT12-	80.8	20.6	25.9	18.3	31.8	33.3	33.3	29.0	23.8
1	3/4	F16-BFC-FNPT12-	84.7	20.6	31.2	22.4	38.1	41.3	41.3	33.7	23.8
1	1	F16-BFC-FNPT16-	93.5	25.4	31.2	22.4	38.1	41.3	41.3	33.7	23.8

Метрическая трубка

NPT Резьба

Трубка, дюйм	P-NPT Резьба	Артикул для заказа	Габариты, мм							Отверстие в панели, мм	Толщина панели, мм
			L	B	C	E	G	F	Gx		
6	1/8	M6-BFC-FNPT2-	47.2	10.4	15.3	4.8	14	16	16	11.5	10.2
6	1/4	M6-BFC-FNPT4-	51.8	15.0	15.3	4.8	14	19	16	11.5	10.2
8	1/8	M8-BFC-FNPT2-	49.6	10.4	16.2	4.8	16	18	18	13.1	11.2
10	1/4	M10-BFC-FNPT4-	55.2	15.0	17.2	7.9	19	22	22	16.3	11.2
12	3/8	M12-BFC-FNPT6-	60.9	15.0	22.8	9.5	22	24	24	19.5	12.7
12	1/2	M12-BFC-FNPT8-	66.5	19.8	22.8	9.5	22	27	24	19.5	12.7

Муфты

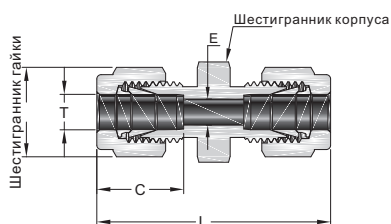

Дюймовая трубка

Трубка, дюйм	Артикул для заказа	Габариты, мм				
		L	C	G	F	E
1/16	F1-U-F1-	25.1	8.6	7.9	11.1	1.3
1/8	F2-U-F2-	35.6	12.7	11.1	11.1	2.3
3/16	F3-U-F3-	37.3	13.7	12.7	12.7	3.0
1/4	F4-U-F4-	40.9	15.2	14.3	12.7	4.8
5/16	F5-U-F5-	42.9	16.2	15.9	14.3	6.4
3/8	F6-U-F6-	45.0	16.8	17.5	15.9	7.1
1/2	F8-U-F8-	51.3	22.9	22.2	20.6	10.4
5/8	F10-U-F10-	52.1	24.4	25.4	23.9	12.7
3/4	F12-U-F12-	53.6	24.4	28.6	27.0	15.7
7/8	F14-U-F14-	55.1	25.9	31.8	34.9	18.3
1	F16-U-F16-	64.8	31.2	38.1	34.9	22.4
1 1/8	F18-U-F18-	64.8	31.2	44.5	41.3	24.6
1 1/4	F20-U-F20-	92.2	41.1	47.6	44.5	27.7
1 1/2	F24-U-F24-	108	50.0	57.2	54.0	34.0

Метрическая трубка

Трубка, дюйм	Артикул для заказа	Габариты, мм				
		L	C	G	F	E
2	M2-U-M2-	35.6	12.9	12	12	1.7
3	M3-U-M3-	35.3	12.9	12	12	2.4
4	M4-U-M4-	37.3	13.7	12	12	2.4
6	M6-U-M6-	41.0	15.3	14	14	4.8
8	M8-U-M8-	43.2	16.2	16	15	6.4
10	M10-U-M10-	46.2	17.2	19	18	7.9
12	M12-U-M12-	51.2	22.8	22	22	9.5
14	M14-U-M14-	52.0	24.4	25	24	11.1
15	M15-U-M15-	52.0	24.4	25	24	11.9
16	M16-U-M16-	52.0	24.4	25	24	12.7
18	M18-U-M18-	53.5	24.4	30	27	15.1
20	M20-U-M20-	55.0	26.0	32	30	15.9
22	M22-U-M22-	55.0	26.0	32	30	18.3
25	M25-U-M25-	65.0	31.3	38	35	21.8
28	M28-U-M28-	85.0	36.6	46	41	21.8
30	M30-U-M30-	92.7	39.6	50	46	26.2
32	M32-U-M32-	97.3	42.0	50	46	28.6
38	M38-U-M38-	113.6	49.4	60	55	33.7

Переходные муфты

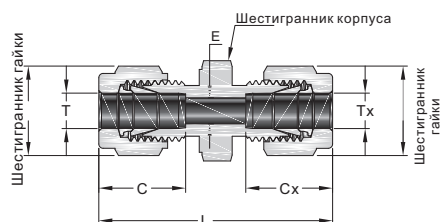

Метрическая трубка

Дюймовая трубка

Трубка, мм	Тх-Трубка, дюйм	Артикул для заказа	Габариты, мм						
			L	C	G	F	E	Cx	Gx
3	1/8	M3-U-F2-	35.2	12.9	12	12	2.4	12.7	11.1
4	1/8	M4-U-F2-	36.5	13.7	12	12	2.4	12.7	11.1
4	1/4	M4-U-F4-	39.4	13.7	12	14	2.4	15.2	14.3
6	1/8	M6-U-F2-	38.5	15.3	14	14	2.4	12.7	11.1
6	1/4	M6-U-F4-	41.0	15.3	14	14	4.8	15.2	14.3
6	5/16	M6-U-F5-	42.3	15.3	14	14	4.8	16.2	15.9
8	1/4	M8-U-F4-	42.3	16.2	16	15	4.8	15.2	14.3
8	3/8	M8-U-F6-	44.3	16.2	16	16	6.4	16.8	17.5
10	1/8	M10-U-F2-	41.8	17.2	19	18	2.4	12.7	11.1
10	1/4	M10-U-F4-	44.5	17.2	19	18	4.8	15.2	14.3
10	5/16	M10-U-F5-	45.1	17.2	19	18	6.4	16.2	15.9
10	3/8	M10-U-F6-	45.9	17.2	19	18	7.1	16.8	17.5
12	5/16	M12-U-F5-	47.8	22.8	22	22	6.4	16.2	15.9
12	3/8	M12-U-F6-	48.4	22.8	22	22	7.1	16.8	17.5
12	1/2	M12-U-F8-	51.2	22.8	22	22	9.5	22.9	22.2
15	1/2	M15-U-F8-	52.0	24.4	25	24	10.4	22.9	22.2
16	5/8	M16-U-F10-	52.0	24.4	25	24	12.7	24.4	25.4
18	3/4	M18-U-F12-	53.5	24.4	30	27	15.1	24.4	28.6
20	1/2	M20-U-F8-	55.0	26.0	32	30	10.4	22.9	22.2
20	1	M20-U-F16-	62.8	26.0	32	35	15.9	31.2	38.1
25	1	M25-U-F16-	65.0	31.3	38	35	21.8	31.2	38.1

Переходные муфты

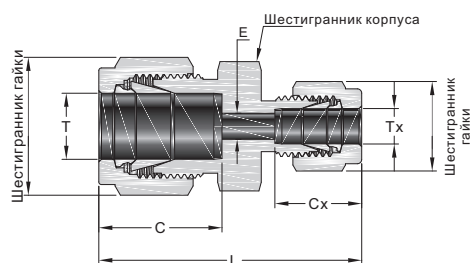

Дюймовая трубка

Трубка, мм	Тх-Трубка, дюйм	Артикул для заказа	Габариты, мм						
			L	C	G	F	E	Cx	Gx
1/8	1/16	F2-U-F1-	31.0	12.7	11.1	11.1	1.3	8.6	7.9
3/16	1/16	F3-U-F1-	32.3	13.7	12.7	11.1	1.3	8.6	7.9
3/16	1/8	F3-U-F2-	36.6	13.7	12.7	11.1	2.3	12.7	11.1
1/4	1/16	F4-U-F1-	34.3	15.2	14.3	12.7	1.3	8.6	7.9
1/4	1/8	F4-U-F2-	38.6	15.2	14.3	12.7	2.3	12.7	11.1
1/4	3/16	F4-U-F3-	39.4	15.2	14.3	12.7	3.0	13.7	12.7
5/16	1/8	F5-U-F2-	39.6	16.2	15.9	14.3	2.3	12.7	11.1
5/16	1/4	F5-U-F4-	42.2	16.2	15.9	14.3	4.8	15.2	14.3
3/8	1/16	F6-U-F1-	36.6	16.8	17.5	15.9	1.3	8.6	7.9
3/8	1/8	F6-U-F2-	40.9	16.8	17.5	15.9	2.3	12.7	11.1
3/8	1/4	F6-U-F4-	43.2	16.8	17.5	15.9	4.8	15.2	14.3
3/8	5/16	F6-U-F5-	44.2	16.8	17.5	15.9	6.4	16.2	15.9
1/2	1/8	F8-U-F2-	45.2	22.8	22.2	20.6	2.3	12.7	11.1
1/2	1/4	F8-U-F4-	47.0	22.8	22.2	20.6	4.8	15.2	14.3
1/2	3/8	F8-U-F6-	48.5	22.8	22.2	20.6	7.1	16.8	17.5
5/8	3/8	F10-U-F6-	49.3	24.4	25.4	23.9	7.1	16.8	17.5
5/8	1/2	F10-U-F8-	52.1	24.4	25.4	23.9	10.4	22.8	22.2
3/4	1/4	F12-U-F4-	49.3	24.4	28.6	27.0	4.8	15.2	14.3
3/4	3/8	F12-U-F6-	50.8	24.4	28.6	27.0	7.1	16.8	17.5
3/4	1/2	F12-U-F8-	53.6	24.4	28.6	27.0	10.4	22.8	22.2
3/4	5/8	F12-U-F10-	53.6	24.4	28.6	27.0	12.7	24.4	25.4
1	1/2	F16-U-F8-	60.5	31.2	38.1	34.9	10.4	22.8	22.2
1	3/4	F16-U-F12-	60.5	31.2	38.1	34.9	15.7	24.4	28.6

Переходные муфты

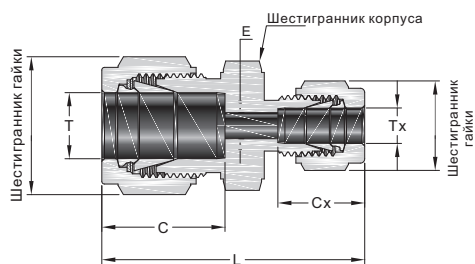

Метрическая трубка

Трубка, мм	Тх-Трубка, мм	Артикул для заказа	Габариты, мм						
			L	C	G	F	E	Cx	Gx
3	2	M3-U-M2-	35.3	12.9	12	12	1.7	12.9	12
6	2	M6-U-M2-	38.6	15.3	14	14	1.7	12.9	12
6	3	M6-U-M3-	38.6	15.3	14	14	2.4	12.9	12
6	4	M6-U-M4-	39.4	15.3	14	14	2.4	13.7	12
8	6	M8-U-M6-	42.3	16.3	16	15	4.8	15.3	14
10	6	M10-U-M6-	44.5	17.2	19	18	4.8	15.3	14
10	8	M10-U-M8-	45.1	17.2	19	18	6.4	16.3	16
12	6	M12-U-M6-	47.0	22.8	22	22	4.8	15.3	14
12	8	M12-U-M8-	47.8	22.8	22	22	6.4	16.3	16
12	10	M12-U-M10-	48.7	22.8	22	22	7.9	17.2	19
16	10	M16-U-M10-	49.5	24.4	25	24	7.9	17.2	19
16	12	M16-U-M12-	52.0	24.4	25	24	9.5	22.8	22
18	12	M18-U-M12-	53.5	24.4	30	27	9.5	22.8	22
25	18	M25-U-M18-	61.0	31.3	38	35	15.1	24.4	30
25	20	M25-U-M20-	62.3	31.3	38	35	15.9	26.0	32
30	18	M30-U-M18-	75.4	39.6	50	46	15.1	24.4	30
30	20	M30-U-M20-	75.4	39.6	50	46	15.9	26.0	32
30	25	M30-U-M25-	80.1	39.6	50	46	21.8	31.3	38
32	18	M32-U-M18-	77.8	42.0	50	46	15.1	24.4	30
32	20	M32-U-M20-	77.8	42.0	50	46	15.9	26.0	32
32	25	M32-U-M25-	82.3	42.0	50	46	21.8	31.3	38
38	20	M38-U-M20-	87.5	49.4	60	55	15.9	26.0	32
38	25	M38-U-M25-	92.0	49.4	60	55	21.8	31.3	38
38	30	M38-U-M30-	104.6	49.4	60	55	26.2	39.6	50

Муфта с монтажом на панель

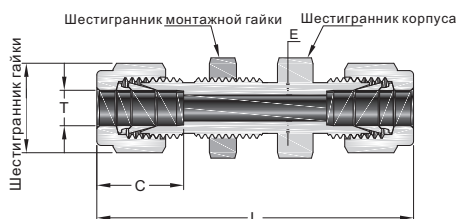

Дюймовая трубка

Тх-Трубка, дюйм	Артикул для заказа	Габариты, мм						Отверстие в панели, мм	Толщина панели, мм
		L	C	E	G	F	Gx		
1/16	F1-BU-F1-	31.5	8.6	1.3	7.9	7.9	7.9	5.2	3.0
1/8	F2-BU-F2-	51.3	12.7	2.3	11.1	12.7	12.7	8.3	12.7
3/16	F3-BU-F3-	53.6	13.7	3.0	12.7	14.3	14.3	9.9	12.7
1/4	F4-BU-F4-	57.7	15.2	4.8	14.3	15.9	15.9	11.5	10.2
5/16	F5-BU-F5-	60.7	16.3	6.4	15.9	17.5	17.5	13.1	11.2
3/8	F6-BU-F6-	62.2	16.8	7.1	17.5	19.1	19.1	14.7	11.2
1/2	F8-BU-F8-	71.1	22.9	10.4	22.2	23.8	23.8	19.4	12.7
5/8	F10-BU-F10-	72.6	24.4	12.7	25.4	27.0	27.0	22.6	12.7
3/4	F12-BU-F12-	79.0	24.4	15.7	28.6	30.2	30.2	25.8	16.8
7/8	F14-BU-F14-	84.6	25.9	18.3	31.8	34.9	34.9	29.0	19.1
1	F16-BU-F16-	95.8	31.2	22.4	38.1	41.3	41.3	33.7	19.1
1 1/4	F20-BU-F20-	123.2	41.1	27.8	47.6	47.6	47.6	41.7	19.1
1 1/2	F24-BU-F24-	139.2	50.0	34.0	57.2	57.2	57.2	49.6	19.1

Метрическая трубка

Тх-Трубка, мм	Артикул для заказа	Габариты, мм						Отверстие в панели, мм	Толщина панели, мм
		L	C	E	G	F	Gx		
3	M3-BU-M3-	51.3	12.9	2.4	12	14	14	8.3	12.7
4	M4-BU-M4-	53.6	13.7	2.4	12	14	14	9.9	12.7
6	M6-BU-M6-	57.7	15.3	4.8	14	16	16	11.5	10.2
8	M8-BU-M8-	61.0	16.2	6.4	16	18	18	13.1	11.2
10	M10-BU-M10-	63.7	17.2	7.9	19	22	22	16.3	11.2
12	M12-BU-M12-	71.0	22.8	9.5	22	24	24	19.5	12.7
14	M14-BU-M14-	72.5	24.4	11.1	25	27	27	22.5	12.7
15	M15-BU-M15-	72.5	24.4	11.9	25	27	27	22.8	12.7
16	M16-BU-M16-	72.5	24.4	12.7	25	27	27	22.8	12.7
18	M18-BU-M18-	78.9	24.4	15.1	30	30	30	26.0	16.8
20	M20-BU-M20-	84.5	26.0	15.9	32	35	35	29.0	19.0
25	M25-BU-M25-	96.0	31.3	21.8	38	41	41	34.0	19.0
30	M30-BU-M30-	124.0	39.6	26.2	50	50	50	40.5	19.0
32	M32-BU-M32-	128.0	42.0	28.6	50	50	50	42.5	19.0
38	M38-BU-M38-	145.0	49.4	33.7	60	60	60	50.5	19.0

Переходная муфта с монтажом на панель

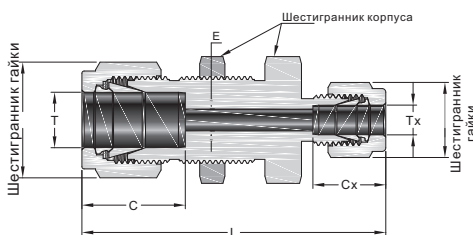

Дюймовая трубка

Трубка, дюйм	Тх-Трубка, дюйм	Артикул для заказа	Габариты, мм								Отверстие в панели, мм	Толщина панели, мм
			L	C	E	G	F	Cx	Gx			
1/4	1/8	F4-BU-F2-	55.1	15.2	2.3	14.3	15.9	12.7	11.1	11.5	10.2	
3/8	1/4	F6-BU-F4-	60.7	16.8	4.8	17.5	19.1	15.2	14.3	14.7	11.2	
1/2	1/4	F8-BU-F4-	66.8	22.9	4.8	22.2	23.8	15.2	14.3	19.4	12.7	

Переходная муфта с монтажом на панель

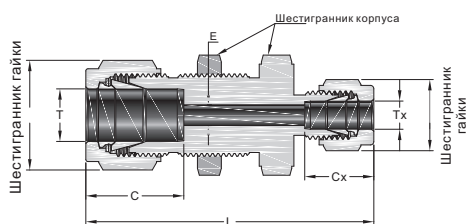

Метрическая трубка

Трубка, мм	Тх-Трубка, мм	Артикул для заказа	Габариты, мм						Отверстие в панели, мм	Толщина панели, мм	
			L	C	E	G	F	Cx			Gx
6	3	M6-BU-M3-	55.1	15.3	2.4	14	16	12.9	12	11.5	10.2
8	6	M8-BU-M6-	60.1	16.2	4.8	16	18	15.3	14	13.1	11.2
12	8	M12-BU-M8-	67.6	22.8	6.4	22	24	16.2	16	19.5	12.7

Угольник с внешней резьбой

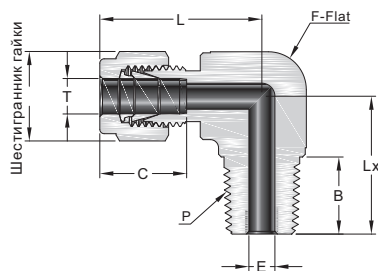

Дюймовая трубка

NPT Резьба

Трубка, дюйм	P-NPT Резьба	Артикул для заказа	Габариты, мм						
			L	C	G	F	E	B	Lx
1/16	1/16	F1-ME-NPT1-	19.1	8.6	7.9	11.1	1.3	9.7	17.8
1/16	1/8	F1-ME-NPT2-	19.1	8.6	7.9	11.1	1.3	9.7	17.8
1/8	1/16	F2-ME-NPT1-	23.6	12.7	11.1	11.1	2.4	9.7	17.8
1/8	1/8	F2-ME-NPT2-	23.6	12.7	11.1	11.1	2.4	9.7	17.8
1/8	1/4	F2-ME-NPT4-	24.6	12.7	11.1	12.7	2.4	14.2	23.4
3/16	1/8	F3-ME-NPT2-	25.4	13.7	12.7	12.7	3.0	9.7	18.8
3/16	1/4	F3-ME-NPT4-	25.4	13.7	12.7	12.7	3.0	14.2	23.4
1/4	1/16	F4-ME-NPT1-	26.9	15.2	14.3	12.7	3.0	9.7	18.8
1/4	1/8	F4-ME-NPT2-	26.9	15.2	14.3	12.7	4.8	9.7	18.8
1/4	1/4	F4-ME-NPT4-	26.9	15.2	14.3	12.7	4.8	14.2	23.4
1/4	3/8	F4-ME-NPT6-	29.7	15.2	14.3	17.5	4.8	14.2	26.2
1/4	1/2	F4-ME-NPT8-	31.8	15.2	14.3	20.6	4.8	19.1	33.0
5/16	1/8	F5-ME-NPT2-	28.7	16.3	15.9	14.3	4.8	9.7	19.8
5/16	1/4	F5-ME-NPT4-	28.7	16.3	15.9	14.3	6.4	14.2	24.4
5/16	3/8	F5-ME-NPT6-	30.5	16.3	15.9	17.5	6.4	14.2	26.2
3/8	1/8	F6-ME-NPT2-	30.5	16.8	17.5	15.9	4.8	9.7	20.8
3/8	1/4	F6-ME-NPT4-	30.5	16.8	17.5	15.9	7.1	14.2	25.4
3/8	3/8	F6-ME-NPT6-	31.2	16.8	17.5	17.5	7.1	14.2	26.2
3/8	1/2	F6-ME-NPT8-	33.3	16.8	17.5	20.6	7.1	19.1	33.0
3/8	3/4	F6-ME-NPT12-	37.1	16.8	17.5	27.0	7.1	19.1	36.8
1/2	1/4	F8-ME-NPT4-	36.1	22.9	22.2	20.6	7.1	14.2	28.2
1/2	3/8	F8-ME-NPT6-	36.1	22.9	22.2	20.6	9.7	14.2	28.2
1/2	1/2	F8-ME-NPT8-	36.1	22.9	22.2	20.6	10.4	19.1	33.0
1/2	3/4	F8-ME-NPT12-	39.9	22.9	22.2	27.0	10.4	19.1	36.8
5/8	3/8	F10-ME-NPT6-	38.1	24.4	25.4	23.8	9.7	14.2	30.2
5/8	1/2	F10-ME-NPT8-	38.1	24.4	25.4	23.8	11.9	19.1	35.1
5/8	3/4	F10-ME-NPT12-	39.9	24.4	25.4	27.0	12.7	19.1	36.8
3/4	1/2	F12-ME-NPT8-	39.9	24.4	28.6	27.0	11.9	19.1	36.8
3/4	3/4	F12-ME-NPT12-	39.9	24.4	28.6	27.0	15.7	19.1	36.8
7/8	3/4	F14-ME-NPT12-	44.7	25.9	31.8	34.9	15.7	19.1	41.7
1	3/4	F16-ME-NPT12-	49.0	31.2	38.1	34.9	15.7	19.1	41.7
1	1	F16-ME-NPT16-	49.0	31.2	38.1	34.9	22.4	23.9	46.5
1 1/4	1 1/4	F20-ME-NPT20-	66.5	41.1	47.6	42.9	27.7	23.9	52.4
1 1/2	1 1/2	F24-ME-NPT24-	78.0	50.0	57.2	50.8	34.0	26.2	60.5

Дюймовая трубка

ISO Коническая резьба (BSPT)

Трубка, дюйм	P-BSPT Резьба	Артикул для заказа	Габариты, мм						
			L	C	G	F	E	B	Lx
1/8	1/8	F2-ME-MBT2-	23.6	12.7	11.1	11.1	2.4	9.7	17.8
1/8	1/4	F2-ME-MBT4-	24.6	12.7	11.1	12.7	2.4	14.2	23.4
1/4	1/8	F4-ME-MBT2-	26.9	15.2	14.3	12.7	4.8	9.7	18.8
1/4	1/4	F4-ME-MBT4-	26.9	15.2	14.3	12.7	4.8	14.2	23.4
1/4	3/8	F4-ME-MBT6-	29.7	15.2	14.3	17.5	4.8	14.2	26.2
1/4	1/2	F4-ME-MBT8-	31.8	15.2	14.3	20.6	4.8	19.1	33.0
5/16	1/4	F5-ME-MBT4-	28.7	16.3	15.9	14.3	6.4	14.2	24.4
3/8	1/8	F6-ME-MBT2-	30.5	16.8	17.5	15.9	4.8	9.7	20.8
3/8	1/4	F6-ME-MBT4-	30.5	16.8	17.5	15.9	7.1	14.2	25.4
3/8	3/8	F6-ME-MBT6-	31.2	16.8	17.5	17.5	7.1	14.2	26.2
1/2	3/8	F8-ME-MBT6-	36.1	22.9	22.2	20.6	9.7	14.2	27.9
1/2	1/2	F8-ME-MBT8-	36.1	22.9	22.2	20.6	10.4	19.1	33.0
3/4	1/2	F12-ME-MBT8-	39.9	24.4	28.6	27.0	11.9	19.1	36.8
1	1	F16-ME-MBT16-	49.0	31.2	38.1	34.9	22.4	23.9	46.5

Угольник с внешней резьбой

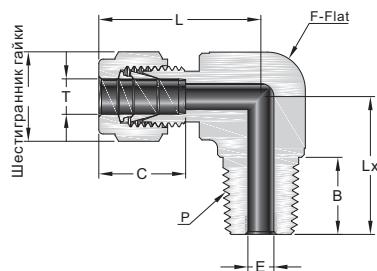

Метрическая трубка

NPT Резьба

Трубка, мм	P-NPT Резьба	Артикул для заказа	Габариты, мм						
			L	C	G	F	E	B	Lx
3	1/8	M3-ME-NPT2-	23.6	12.9	12	11.1	2.4	9.7	17.8
3	1/4	M3-ME-NPT4-	24.6	12.9	12	12.7	2.4	14.2	23.4
4	1/8	M4-ME-NPT2-	25.4	13.7	12	12.7	2.4	9.7	18.8
4	1/4	M4-ME-NPT4-	25.4	13.7	12	12.7	2.4	14.2	23.4
6	1/8	M6-ME-NPT2-	27.0	15.3	14	12.7	4.8	9.7	18.8
6	1/4	M6-ME-NPT4-	27.0	15.3	14	12.7	4.8	14.2	23.4
6	3/8	M6-ME-NPT6-	29.8	15.3	14	17.5	4.8	14.2	26.2
6	1/2	M6-ME-NPT8-	31.8	15.3	14	20.6	4.8	19.0	33.0
8	1/8	M8-ME-NPT2-	28.8	16.2	16	14.3	4.8	9.7	19.8
8	1/4	M8-ME-NPT4-	28.8	16.2	16	14.3	6.4	14.2	24.4
8	3/8	M8-ME-NPT6-	30.6	16.2	16	17.5	6.4	14.2	26.2
8	1/2	M8-ME-NPT8-	32.6	16.2	16	20.6	6.4	19.1	33.0
10	1/8	M10-ME-NPT2-	31.5	17.2	19	17.5	4.8	9.7	21.6
10	1/4	M10-ME-NPT4-	31.5	17.2	19	17.5	7.1	14.2	26.2
10	3/8	M10-ME-NPT6-	31.5	17.2	19	17.5	7.9	14.2	26.2
10	1/2	M10-ME-NPT8-	33.5	17.2	19	20.6	7.9	19.1	33.0
12	1/8	M12-ME-NPT2-	36.0	22.8	22	20.6	4.8	9.7	23.6
12	1/4	M12-ME-NPT4-	36.0	22.8	22	20.6	7.1	14.2	28.2
12	3/8	M12-ME-NPT6-	36.0	22.8	22	20.6	9.5	14.2	28.2
12	1/2	M12-ME-NPT8-	36.0	22.8	22	20.6	9.5	19.1	33.0
12	3/4	M12-ME-NPT12-	39.8	22.8	22	27.0	9.5	19.1	36.8
15	1/2	M15-ME-NPT8-	38.0	24.4	25	23.8	11.9	19.1	35.1
16	1/4	M16-ME-NPT4-	38.0	24.4	25	23.8	7.1	14.2	30.2
16	3/8	M16-ME-NPT6-	38.0	24.4	25	23.8	9.5	14.2	30.2
16	1/2	M16-ME-NPT8-	38.0	24.4	25	23.8	11.9	19.1	35.1
16	3/4	M16-ME-NPT12-	39.8	24.4	25	27.0	12.7	19.1	36.8
18	1/2	M18-ME-NPT8-	39.8	24.4	30	27.0	11.9	19.1	36.8
18	3/4	M18-ME-NPT12-	39.8	24.4	30	27.0	15.1	19.1	36.8
20	1/2	M20-ME-NPT8-	44.6	26.0	32	34.9	11.9	19.1	41.7
20	3/4	M20-ME-NPT12-	44.6	26.0	32	34.9	15.9	19.1	41.7
22	3/4	M22-ME-NPT12-	44.6	26.0	32	34.9	15.9	19.1	41.7
22	1	M22-ME-NPT16-	44.6	26.0	32	34.9	18.3	23.9	46.5
25	3/4	M25-ME-NPT12-	49.1	31.3	38	34.9	15.9	19.0	41.7
25	1	M25-ME-NPT16-	49.1	31.3	38	34.9	21.8	23.9	46.5
30	1 1/4	M30-ME-NPT20-	69.9	39.6	50	42.9	26.2	23.9	53.1
32	1 1/4	M32-ME-NPT20-	72.3	42.0	50	42.9	27.8	23.9	53.1
38	1 1/2	M38-ME-NPT24-	84.0	49.4	60	50.8	33.7	26.2	60.4

Угольник с внешней резьбой

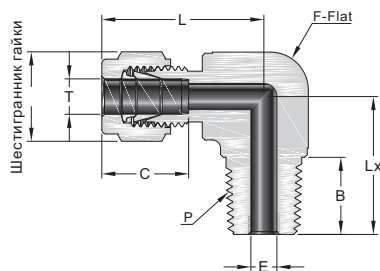

Метрическая трубка

ISO Коническая резьба (BSPT)

Трубка, мм	P-BSPT Резьба	Артикул для заказа	Габариты, мм						
			L	C	G	F	E	B	Lx
3	1/8	M3-ME-MBT2-	23.6	12.9	12	11.1	2.4	9.7	17.8
3	1/4	M3-ME-MBT4-	24.6	12.9	12	12.7	2.4	14.2	23.4
4	1/8	M4-ME-MBT2-	25.4	13.7	12	12.7	2.4	9.7	18.8
4	1/4	M4-ME-MBT4-	25.4	13.7	12	12.7	2.4	14.2	23.4
6	1/8	M6-ME-MBT2-	27.0	15.3	14	12.7	4.8	9.7	18.8
6	1/4	M6-ME-MBT4-	27.0	15.3	14	12.7	4.8	14.2	23.4
6	3/8	M6-ME-MBT6-	29.8	15.3	14	17.5	4.8	14.2	26.2
6	1/2	M6-ME-MBT8-	31.8	15.3	14	20.6	4.8	19.0	33.0
8	1/8	M8-ME-MBT2-	28.8	16.2	16	14.3	4.8	9.7	19.8
8	1/4	M8-ME-MBT4-	28.8	16.2	16	14.3	6.4	14.2	24.4
8	3/8	M8-ME-MBT6-	30.6	16.2	16	17.5	6.4	14.2	26.2
8	1/2	M8-ME-MBT8-	32.6	16.2	16	20.6	6.4	19.1	33.0
10	1/8	M10-ME-MBT2-	31.5	17.2	19	17.5	4.8	9.7	21.6
10	1/4	M10-ME-MBT4-	31.5	17.2	19	17.5	7.1	14.2	26.2
10	3/8	M10-ME-MBT6-	31.5	17.2	19	17.5	7.9	14.2	26.2
10	1/2	M10-ME-MBT8-	33.5	17.2	19	20.6	7.9	19.1	33.0
12	1/8	M12-ME-MBT2-	36.0	22.8	22	20.6	4.8	9.7	23.6
12	1/4	M12-ME-MBT4-	36.0	22.8	22	20.6	7.1	14.2	28.2
12	3/8	M12-ME-MBT6-	36.0	22.8	22	20.6	9.5	14.2	28.2
12	1/2	M12-ME-MBT8-	36.0	22.8	22	20.6	9.5	19.1	33.0
12	3/4	M12-ME-MBT12-	39.8	22.8	22	27.0	9.5	19.1	36.8
14	1/2	M14-ME-MBT8-	38.1	24.4	25	23.8	11.1	19.1	35.1
15	1/2	M15-ME-MBT8-	38.1	24.4	25	23.8	11.9	19.1	35.1
16	1/4	M16-ME-MBT4-	38.0	24.4	25	23.8	7.1	14.2	30.2
16	3/8	M16-ME-MBT6-	38.0	24.4	25	23.8	9.5	14.2	30.2
16	1/2	M16-ME-MBT8-	38.0	24.4	25	23.8	11.9	19.1	35.1
16	3/4	M16-ME-MBT12-	39.8	24.4	25	27.0	12.7	19.1	36.8
18	1/2	M18-ME-MBT8-	39.8	24.4	30	27.0	11.9	19.1	36.8
18	3/4	M18-ME-MBT12-	39.8	24.4	30	27.0	15.1	19.1	36.8
20	1/2	M20-ME-MBT8-	44.6	26.0	32	34.9	11.9	19.1	41.7
20	3/4	M20-ME-MBT12-	44.6	26.0	32	34.9	15.9	19.1	41.7
22	3/4	M22-ME-MBT12-	44.6	26.0	32	34.9	15.9	19.1	41.7
22	1	M22-ME-MBT16-	44.6	26.0	32	34.9	18.3	23.9	46.5
25	3/4	M25-ME-MBT12-	49.1	31.3	38	34.9	15.9	19.1	41.7
25	1	M25-ME-MBT16-	49.1	31.3	38	34.9	21.8	23.9	46.5
28	1	M28-ME-MBT16-	64.0	36.6	46	42.9	21.8	23.9	53.1

Угольник под 45° с внешней резьбой

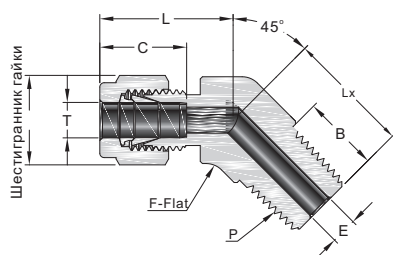

Дюймовая трубка

NPT Резьба

Трубка, дюйм	P-NPT Резьба	Артикул для заказа	Габариты, мм						
			L	C	G	F	E	B	Lx
1/16	1/16	F1-45ME-NPT1-	15.7	8.6	7.9	9.5	1.3	9.7	14.5
1/8	1/8	F2-45ME-NPT2-	20.8	12.7	11.1	11.1	2.3	9.7	16.8
3/16	1/8	F3-45ME-NPT2-	21.6	13.7	12.7	11.1	3.0	9.7	14.7
1/4	1/8	F4-45ME-NPT2-	24.6	15.2	14.3	12.7	4.8	9.7	16.5
1/4	1/4	F4-45ME-NPT4-	24.6	15.2	14.3	12.7	4.8	14.3	21.1
5/16	1/8	F5-45ME-NPT2-	24.1	16.3	15.9	14.3	4.8	9.7	16.8
3/8	1/8	F6-45ME-NPT2-	27.9	16.8	17.5	15.9	4.8	9.7	18.3
3/8	1/4	F6-45ME-NPT4-	27.9	16.8	17.5	15.9	7.1	14.3	22.9
3/8	3/8	F6-45ME-NPT6-	29.2	16.8	17.5	20.6	7.1	19.1	24.1
1/2	3/8	F8-45ME-NPT6-	32.0	22.9	22.2	20.6	9.7	19.1	24.1
5/8	1/2	F10-45ME-NPT8-	30.7	24.4	25.4	23.8	11.9	19.1	29.7
3/4	3/4	F12-45ME-NPT12-	34.0	24.4	28.6	27.0	15.7	19.1	31.0
7/8	3/4	F14-45ME-NPT12-	40.4	25.9	31.8	31.8	15.7	19.1	32.3
1	1	F16-45ME-NPT16-	40.4	31.2	38.1	34.9	22.4	23.9	37.8

Метрическая трубка

NPT Резьба

Трубка, мм	P-NPT Резьба	Артикул для заказа	Габариты, мм						
			L	C	G	F	E	B	Lx
6	1/8	M6-45ME-NPT2-	23.4	15.3	14	12.7	4.8	9.7	16.8
6	1/4	M6-45ME-NPT4-	23.4	15.3	14	12.7	4.8	14.3	21.8
8	1/8	M8-45ME-NPT2-	24.3	16.2	16	15.9	4.8	9.7	16.8
10	1/4	M10-45ME-NPT4-	26.6	17.2	19	17.5	7.9	14.3	24.1
12	3/8	M12-45ME-NPT6-	29.1	22.8	22	20.6	9.5	19.1	24.1
12	1/2	M12-45ME-NPT8-	30.7	22.8	22	20.6	9.5	19.1	29.7
16	1/2	M16-45ME-NPT8-	30.7	24.4	25	23.8	11.9	19.1	29.7

Позиционируемый угольник с внешней резьбой

SAE/MS Прямая резьба

Adapt to straight thread boss of SAE J1926-1,
ISO 11926-1 and MS 16142.

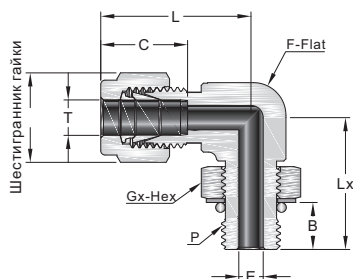

Дюймовая трубка

SAE/MS Прямая резьба

Трубка, дюйм	P-SAE/MS Размер резьбы	Артикул для заказа	Габариты, мм							
			L	B	C	G	E	F	Lx	Gx
1/4	7/16-20	F4-PME-PST7-	28.4	9.9	15.2	14.3	4.8	12.7	28.4	14.3
1/4	9/16-18	F4-PME-PST9-	30.5	11.2	15.2	14.3	4.8	15.9	32.3	17.5
5/16	1/2-20	F5-PME-PST8-	30.2	9.9	16.3	15.9	5.8	14.3	29.5	15.9
3/8	7/16-20	F6-PME-PST7-	33.3	9.9	16.8	17.5	5.1	15.9	31.5	14.3
3/8	9/16-18	F6-PME-PST9-	32.0	11.2	16.8	17.5	7.1	15.9	32.3	17.5
3/8	3/4-16	F6-PME-PST12-	34.8	12.7	16.8	17.5	7.1	20.6	37.8	22.2
1/2	9/16-18	F8-PME-PST9-	37.6	11.2	22.9	22.2	7.1	20.6	37.5	17.5
1/2	3/4-16	F8-PME-PST12-	37.6	12.7	22.9	22.2	10.4	20.6	37.8	22.2
5/8	7/8-14	F10-PME-PST14-	39.6	14.2	24.4	25.4	12.7	23.8	43.4	25.4
3/4	1 1/16-12	F12-PME-PST17-	41.4	16.8	24.4	28.6	15.7	27.0	48.8	31.8
7/8	1 3/16-12	F14-PME-PST19-	43.2	16.8	25.9	31.8	18.3	30.2	50.5	34.9
1	1 5/16-12	F16-PME-PST21-	50.5	16.8	31.2	38.1	22.4	34.9	53.6	38.1
1 1/4	1 5/8-12	F20-PME-PST26-	67.8	16.8	41.1	47.6	27.7	42.9	58.2	47.6
1 1/2	1 7/8-12	F24-PME-PST30-	78.0	16.8	50.0	57.2	34.0	50.8	60.5	54.0

Позиционируемый угольник с внешней резьбой

ISO Цилиндрическая резьба

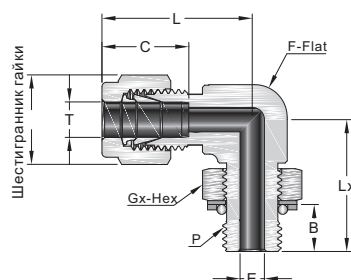

Дюймовая трубка

ISO Цилиндрическая резьба (PPT)

Трубка, дюйм	P-ISO Размер цилиндрической резьбы	Артикул для заказа	Габариты, мм							
			L	B	C	G	E	F	Lx	Gx
1/4	1/8	F4-PME-PPT2-	26.9	8.1	15.2	14.3	4.1	12.7	26.4	14.3
1/4	1/4	F4-PME-PPT4-	29.0	9.1	15.2	14.3	4.8	15.9	32.3	19.1
3/8	1/4	F6-PME-PPT4-	30.5	9.1	16.8	17.5	5.8	15.9	32.3	19.1
3/8	3/8	F6-PME-PPT6-	33.3	9.4	16.8	17.5	7.1	20.6	37.1	22.2
1/2	1/4	F8-PME-PPT4-	36.1	9.1	22.9	22.2	5.8	20.6	35.1	19.1
1/2	3/8	F8-PME-PPT6-	36.1	9.4	22.9	22.2	7.9	20.6	37.1	22.2
1/2	1/2	F8-PME-PPT8-	38.1	13.0	22.9	22.2	10.4	23.8	43.4	27.0
5/8	1/2	F10-PME-PPT8-	38.1	13.0	24.4	25.4	11.9	23.8	43.4	27.0
3/4	1/2	F12-PME-PPT8-	39.9	13.0	24.4	28.6	11.9	27.0	45.2	27.0
3/4	3/4	F12-PME-PPT12-	39.9	13.0	24.4	28.6	15.7	27.0	48.8	34.9
1	3/4	F16-PME-PPT12-	49.0	13.0	31.2	38.1	15.7	34.9	53.3	34.9
1	1	F16-PME-PPT16-	49.0	14.0	31.2	38.1	19.8	34.9	53.6	41.3

Метрическая трубка

ISO Цилиндрическая резьба (PPT)

Трубка, мм	P-ISO Размер цилиндрической резьбы	Артикул для заказа	Габариты, мм							
			L	B	C	G	E	F	Lx	Gx
6	1/8	M6-PME-PPT2-	27.0	8.1	15.3	14	4.0	12.7	26.4	14.3
6	1/4	M6-PME-PPT4-	29.0	9.1	15.3	14	4.8	15.9	32.3	19.1
8	1/8	M8-PME-PPT2-	28.8	8.1	16.2	16	4.0	14.3	27.4	14.3
8	1/4	M8-PME-PPT4-	29.9	9.1	16.2	16	5.9	15.9	32.2	19.1
10	1/4	M10-PME-PPT4-	33.5	9.1	17.2	19	5.9	20.6	35.0	19.1
10	3/8	M10-PME-PPT6-	33.5	9.4	17.2	19	7.9	20.6	37.1	22.2
12	1/4	M12-PME-PPT4-	36.0	9.1	22.8	22	5.9	20.6	35.0	19.1
12	3/8	M12-PME-PPT6-	36.0	9.4	22.8	22	7.9	20.6	37.1	22.2
12	1/2	M12-PME-PPT8-	38.0	13.0	22.8	22	9.5	23.8	43.4	27.0
12	3/4	M12-PME-PPT12-	39.8	13.0	22.8	22	9.5	27.0	48.8	34.9

Позиционируемый угольник под 45° с внешней резьбой

SAE/MS Прямая резьба

Адаптер по стандартам

SAE J1926-1, ISO 11926-1 и MS 16142

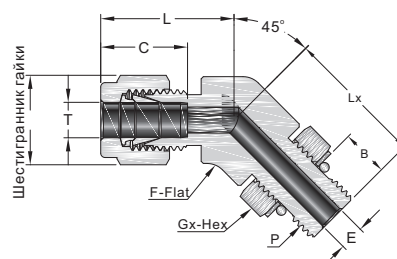

Дюймовая трубка

SAE/MS Прямая резьба

Трубка, дюйм	P-SAE/MS Размер резьбы	Артикул для заказа	Габариты, мм							
			L	B	C	G	E	F	Lx	Gx
1/4	7/16-20	F4-45PME-PST7-	25.7	9.9	15.2	14.3	4.8	12.7	25.7	14.3
3/8	9/16-18	F6-45PME-PST9-	27.9	11.2	16.8	17.5	7.1	15.9	28.2	17.5
1/2	3/4-16	F8-45PME-PST12-	32.0	12.7	22.9	22.2	10.4	20.6	32.3	22.2
3/4	1 1/16-12	F12-45PME-PST17-	39.9	16.8	24.4	28.6	15.7	27.0	47.2	31.8
1	1 5/16-12	F16-45PME-PST21-	47.5	16.8	31.2	38.1	22.4	33.3	50.5	38.1

Угольник с внутренней резьбой

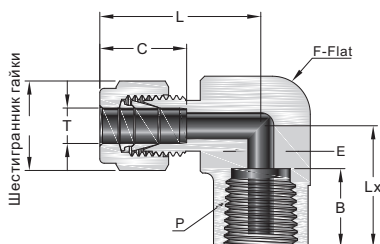

Дюймовая трубка

NPT Резьба

Трубка, дюйм	P-NPT Резьба	Артикул для заказа	Габариты, мм						
			L	B	C	G	E	F	Lx
1/16	1/16	F1-FE-FNPT1-	18.0	9.9	8.6	7.9	1.3	11.1	14.2
1/16	1/8	F1-FE-FNPT2-	20.6	10.4	8.6	7.9	1.3	14.3	19.1
1/8	1/8	F2-FE-FNPT2-	24.6	10.4	12.7	11.1	2.3	14.3	19.1
1/8	1/4	F2-FE-FNPT4-	27.4	15.0	12.7	11.1	2.3	17.5	22.4
3/16	1/8	F3-FE-FNPT2-	25.4	10.4	13.7	12.7	3.0	12.7	19.1
1/4	1/8	F4-FE-FNPT2-	26.9	10.4	15.2	14.3	4.8	14.3	19.1
1/4	1/4	F4-FE-FNPT4-	29.7	15.0	15.2	14.3	4.8	17.5	22.4
1/4	3/8	F4-FE-FNPT6-	31.8	15.0	15.2	14.3	4.8	20.6	22.4
1/4	1/2	F4-FE-FNPT8-	34.5	19.8	15.2	14.3	4.8	25.4	28.4
5/16	1/8	F5-FE-FNPT2-	28.7	10.4	16.3	15.9	6.4	14.3	19.1
5/16	1/4	F5-FE-FNPT4-	30.5	15.0	16.3	15.9	6.4	17.5	22.4
3/8	1/8	F6-FE-FNPT2-	30.5	10.4	16.8	17.5	7.1	15.9	19.1
3/8	1/4	F6-FE-FNPT4-	31.2	15.0	16.8	17.5	7.1	17.5	22.4
3/8	3/8	F6-FE-FNPT6-	33.3	15.0	16.8	17.5	7.1	20.6	22.4
3/8	1/2	F6-FE-FNPT8-	36.1	19.8	16.8	17.5	7.1	25.4	28.4
1/2	1/4	F8-FE-FNPT4-	36.1	15.0	22.9	22.2	10.4	20.6	22.4
1/2	3/8	F8-FE-FNPT6-	36.1	15.0	22.9	22.2	10.4	20.6	22.4
1/2	1/2	F8-FE-FNPT8-	38.9	19.8	22.9	22.2	10.4	25.4	28.4
5/8	3/8	F10-FE-FNPT6-	38.1	15.0	24.4	25.4	12.7	23.8	22.4
5/8	1/2	F10-FE-FNPT8-	39.9	19.8	24.4	25.4	12.7	27.0	28.4
3/4	1/2	F12-FE-FNPT8-	39.9	19.8	24.4	28.6	15.7	27.0	28.4
3/4	3/4	F12-FE-FNPT12-	44.7	20.6	24.4	28.6	15.7	34.9	31.8
7/8	3/4	F14-FE-FNPT12-	44.7	20.6	25.9	31.8	18.3	34.9	31.8
1	3/4	F16-FE-FNPT12-	49.0	20.6	31.2	38.1	22.4	34.9	31.8
1	1	F16-FE-FNPT16-	53.6	25.4	31.2	38.1	22.4	42.9	38.1

Метрическая трубка

NPT Резьба

Трубка, мм	P-NPT Резьба	Артикул для заказа	Габариты, мм						
			L	B	C	G	E	F	Lx
6	1/8	M6-FE-FNPT2-	27.0	10.4	15.3	14	4.8	12.7	19.0
6	1/4	M6-FE-FNPT4-	29.8	15.0	15.3	14	4.8	17.5	22.4
8	1/8	M8-FE-FNPT2-	28.8	10.4	16.2	16	4.8	14.3	19.1
8	1/4	M8-FE-FNPT4-	30.6	15.0	16.2	16	6.4	17.5	22.4
10	1/4	M10-FE-FNPT4-	33.5	15.0	17.2	19	7.9	20.6	22.4
10	3/8	M10-FE-FNPT6-	33.5	15.0	17.2	19	7.9	20.6	22.4
10	1/2	M10-FE-FNPT8-	36.6	19.8	17.2	19	7.9	25.4	28.5
12	1/4	M12-FE-FNPT4-	36.0	15.0	22.8	22	7.9	20.6	22.4
12	3/8	M12-FE-FNPT6-	36.0	15.0	22.8	22	9.5	20.6	22.4
12	1/2	M12-FE-FNPT8-	38.8	19.8	22.8	22	9.5	25.4	28.4
16	3/8	M16-FE-FNPT6-	39.5	15.0	24.4	25	9.5	27.0	23.6
16	1/2	M16-FE-FNPT8-	39.5	19.8	24.4	25	12.7	27.0	28.5

Соединительный угольник

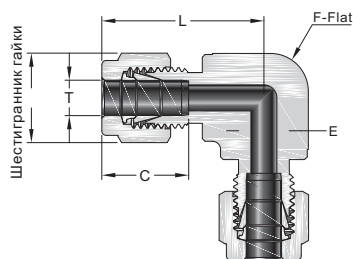

Дюймовая трубка

Трубка, дюйм	Артикул для заказа	Габариты, мм				
		L	C	G	F	E
1/16	F1-UE-F1-	17.8	8.6	7.9	9.5	1.3
1/8	F2-UE-F2-	22.4	12.7	11.1	9.5	2.3
3/16	F3-UE-F3-	25.4	13.7	12.7	12.7	3.0
1/4	F4-UE-F4-	26.9	15.2	14.3	12.7	4.8
5/16	F5-UE-F5-	28.7	16.3	15.9	14.3	6.4
3/8	F6-UE-F6-	30.5	16.8	17.5	15.9	7.1
1/2	F8-UE-F8-	36.1	22.9	22.2	20.6	10.4
5/8	F10-UE-F10-	38.1	24.4	25.4	23.8	12.7
3/4	F12-UE-F12-	39.9	24.4	28.6	27.0	15.7
7/8	F14-UE-F14-	44.7	25.9	31.8	34.9	18.3
1	F16-UE-F16-	49.0	31.2	38.1	34.9	22.4
1 1/8	F18-UE-F18-	55.1	31.2	41.3	42.9	24.6
1 1/4	F20-UE-F20-	66.5	41.1	47.6	42.9	27.7
1 1/2	F24-UE-F24-	78.0	50.0	57.2	50.8	34.0

Метрическая трубка

Трубка, мм	Артикул для заказа	Габариты, мм				
		L	C	G	F	E
3	M3-UE-M3-	22.3	12.9	12	9.5	2.4
4	M4-UE-M4-	25.4	13.7	12	12.7	2.4
6	M6-UE-M6-	27.0	15.3	14	12.7	4.8
8	M8-UE-M8-	28.8	16.2	16	14.3	6.4
10	M10-UE-M10-	31.5	17.2	19	17.5	7.9
12	M12-UE-M12-	36.0	22.8	22	20.6	9.5
14	M14-UE-M14-	38.0	24.4	25	23.8	11.0
15	M15-UE-M15-	38.8	24.4	25	23.8	11.9
16	M16-UE-M16-	38.0	24.4	25	23.8	12.7
18	M18-UE-M18-	39.8	24.4	30	27.0	15.1
20	M20-UE-M20-	44.6	26.0	32	34.9	15.9
22	M22-UE-M22-	44.6	26.0	32	34.9	18.3
25	M25-UE-M25-	49.1	31.3	38	34.9	21.8
28	M28-UE-M28-	64.0	36.6	46	42.9	21.8
30	M30-UE-M30-	69.9	39.6	50	42.9	26.2
32	M32-UE-M32-	72.3	42.0	50	42.9	28.6
38	M38-UE-M38-	84.0	49.4	60	50.8	33.7

Переходной угольник

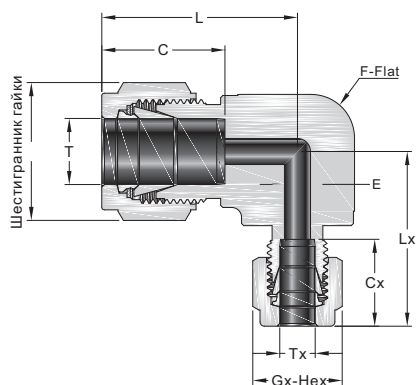

Дюймовая трубка

Трубка, дюйм	Tx Трубка, дюйм	Артикул для заказа	Габариты, мм							
			L	C	G	F	E	Cx	Gx	Lx
3/16	1/8	F3-UE-F2-	25.4	13.7	12.7	12.7	2.3	12.7	11.1	24.7
1/4	1/8	F4-UE-F2-	26.9	15.2	14.3	12.7	2.3	12.7	11.1	25.4
5/16	1/8	F5-UE-F2-	29.7	16.3	15.9	14.3	2.3	12.7	11.1	26.4
5/16	1/4	F5-UE-F4-	29.7	16.3	15.9	14.3	4.8	15.2	14.3	29.0
3/8	1/8	F6-UE-F2-	30.5	16.8	17.5	15.9	2.3	12.7	11.1	26.4
3/8	1/4	F6-UE-F4-	30.5	16.8	17.5	15.9	4.8	15.2	14.3	29.0
3/8	5/16	F6-UE-F5-	30.5	16.8	17.5	15.9	6.4	16.3	15.9	29.7
1/2	1/4	F8-UE-F4-	36.1	22.9	22.2	20.6	4.8	15.2	14.3	32.2
1/2	5/16	F8-UE-F5-	36.1	22.9	22.2	20.6	6.4	16.3	15.9	32.5
1/2	3/8	F8-UE-F6-	36.1	22.9	22.2	20.6	7.1	16.8	17.5	33.6
5/8	3/8	F10-UE-F6-	38.1	24.4	25.4	23.8	7.1	16.8	17.5	35.6
5/8	1/2	F10-UE-F8-	38.1	24.4	25.4	23.8	10.4	22.9	22.2	38.1
3/4	1/4	F12-UE-F4-	39.9	24.4	28.6	27.0	4.8	15.2	14.3	35.9
3/4	3/8	F12-UE-F6-	39.9	24.4	28.6	27.0	7.1	16.8	17.5	37.4
3/4	1/2	F12-UE-F8-	39.9	24.4	28.6	27.0	10.4	22.9	22.2	39.9
7/8	1/4	F14-UE-F4-	44.7	25.9	31.8	34.9	4.8	15.2	14.3	40.7
1	1/2	F16-UE-F8-	49.0	31.2	38.1	34.9	10.4	22.9	22.2	44.4
1	3/4	F16-UE-F12-	49.0	31.2	38.1	34.9	15.7	24.4	28.6	44.4

Метрическая трубка

Трубка, мм	Tx Трубка, мм	Артикул для заказа	Габариты, мм							
			L	C	G	F	E	Cx	Gx	Lx
8	6	M8-UE-M6-	28.8	16.2	16	14.3	4.8	15.3	14	27.9
10	8	M10-UE-M8-	31.5	17.2	19	17.5	6.4	16.2	16	30.5
12	8	M12-UE-M8-	36.0	22.8	22	20.6	6.4	16.2	16	32.6
14	8	M14-UE-M8-	38.8	24.4	25	23.8	6.4	16.2	16	35.4
14	10	M14-UE-M10-	38.8	24.4	25	23.8	7.9	17.2	19	36.4

Тройник с внешней резьбой снизу

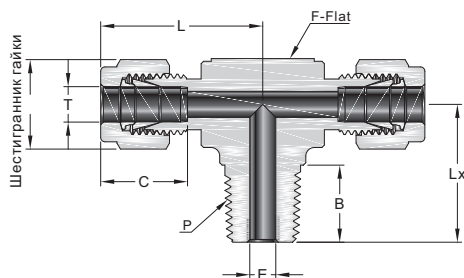

Дюймовая трубка

NPT Резьба

Трубка, дюйм	P-NPT Резьба	Артикул для заказа	Габариты, мм						
			L	C	G	F	E	B	Lx
1/8	1/8	F2-MBT-F2-NPT2-	23.6	12.7	11.1	11.1	2.3	9.7	17.8
1/8	1/4	F2-MBT-F2-NPT4-	24.6	12.7	11.1	12.7	2.3	14.2	23.4
3/16	1/8	F3-MBT-F3-NPT2-	24.4	13.7	12.7	11.1	3.0	9.7	17.8
1/4	1/8	F4-MBT-F4-NPT2-	26.9	15.2	14.3	12.7	4.8	9.7	18.8
1/4	1/4	F4-MBT-F4-NPT4-	26.9	15.2	14.3	12.7	4.8	14.2	23.4
5/16	1/8	F5-MBT-F5-NPT2-	29.7	16.3	15.9	15.9	4.8	9.7	20.8
5/16	1/4	F5-MBT-F5-NPT4-	29.7	16.3	15.9	15.9	6.4	14.2	25.7
3/8	1/4	F6-MBT-F6-NPT4-	30.5	16.8	17.5	15.9	7.1	14.2	25.4
3/8	3/8	F6-MBT-F6-NPT6-	33.3	16.8	17.5	20.6	7.1	14.2	28.2
1/2	3/8	F8-MBT-F8-NPT6-	36.1	22.9	22.2	20.6	9.7	14.2	28.2
1/2	1/2	F8-MBT-F8-NPT8-	36.1	22.9	22.2	20.6	10.4	19.1	33.0
5/8	1/2	F10-MBT-F10-NPT8-	38.9	24.4	25.4	25.4	11.9	19.1	35.8
3/4	3/4	F12-MBT-F12-NPT12-	39.9	24.4	28.6	27.0	15.7	19.1	36.8
7/8	3/4	F14-MBT-F14-NPT12-	44.7	25.9	31.8	33.3	15.7	19.1	38.1
1	3/4	F16-MBT-F16-NPT12-	49.3	31.2	38.1	33.3	15.7	19.1	42.2
1	1	F16-MBT-F16-NPT16-	49.3	31.2	38.1	34.9	22.4	23.9	46.7

Метрическая трубка

NPT Резьба

Трубка, мм	P-NPT Резьба	Артикул для заказа	Габариты, мм						
			L	C	G	F	E	B	Lx
6	1/8	M6-MBT-M6-NPT2-	27.0	15.3	14	12.7	4.8	9.7	18.8
6	1/4	M6-MBT-M6-NPT4-	27.0	15.3	14	12.7	4.8	14.2	23.4
8	1/8	M8-MBT-M8-NPT2-	29.9	16.2	16	15.9	4.8	9.7	20.8
8	1/4	M8-MBT-M8-NPT4-	29.9	16.2	16	15.9	6.4	14.2	25.4
10	1/4	M10-MBT-M10-NPT4-	33.5	17.2	19	20.6	7.9	14.2	28.2
10	3/8	M10-MBT-M10-NPT6-	33.5	17.2	19	20.6	7.9	14.2	28.2
12	1/4	M12-MBT-M12-NPT4-	36.0	22.8	22	20.6	7.9	14.2	28.2
12	3/8	M12-MBT-M12-NPT6-	36.0	22.8	22	20.6	9.5	14.2	28.2
12	1/2	M12-MBT-M12-NPT8-	36.0	22.8	22	20.6	9.5	19.1	33.0
16	1/2	M16-MBT-M16-NPT8-	38.8	24.4	25	25.4	11.9	19.1	35.8

Тройник с внешней резьбой сбоку

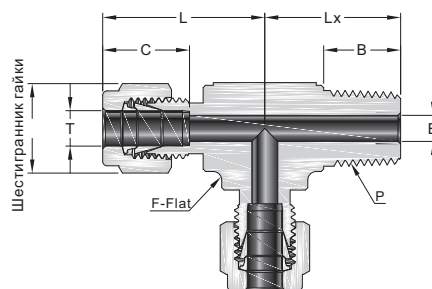

Дюймовая трубка

NPT Резьба

Трубка, дюйм	P-NPT Резьба	Артикул для заказа	Габариты, мм						
			L	C	G	F	E	B	Lx
1/8	1/8	F2-MRT-NPT2-F2-	23.6	12.7	11.1	11.1	2.3	9.7	17.8
1/8	1/4	F2-MRT-NPT4-F2-	24.6	12.7	11.1	12.7	2.3	14.2	23.4
3/16	1/8	F3-MRT-NPT2-F3-	24.4	13.7	12.7	11.1	3.0	9.7	17.8
1/4	1/8	F4-MRT-NPT2-F4-	26.9	15.2	14.3	12.7	4.8	9.7	18.8
1/4	1/4	F4-MRT-NPT4-F4-	26.9	15.2	14.3	12.7	4.8	14.2	23.4
5/16	1/8	F5-MRT-NPT2-F5-	29.7	16.3	15.9	15.9	4.8	9.7	20.8
5/16	1/4	F5-MRT-NPT4-F5-	29.7	16.3	15.9	15.9	6.4	14.2	25.7
3/8	1/4	F6-MRT-NPT4-F6-	30.5	16.8	17.5	15.9	7.1	14.2	25.4
3/8	3/8	F6-MRT-NPT6-F6-	33.3	16.8	17.5	20.6	7.1	14.2	28.2
1/2	3/8	F8-MRT-NPT6-F8-	36.1	22.9	22.2	20.6	9.7	14.2	28.2
1/2	1/2	F8-MRT-NPT8-F8-	36.1	22.9	22.2	20.6	10.4	19.1	33.0
5/8	1/2	F10-MRT-NPT8-F10-	38.1	24.4	25.4	23.8	11.9	19.1	35.8
3/4	3/4	F12-MRT-NPT12-F12-	39.9	24.4	28.6	27.0	15.7	19.1	36.8
7/8	3/4	F14-MRT-NPT12-F14-	44.7	25.9	31.8	33.3	15.7	19.1	38.1
1	3/4	F16-MRT-NPT12-F16-	49.3	31.2	38.1	33.3	15.7	19.1	42.2
1	1	F16-MRT-NPT16-F16-	49.3	31.2	38.1	34.9	22.4	23.9	46.7

Метрическая трубка

NPT Резьба

Трубка, мм	P-NPT Резьба	Артикул для заказа	Габариты, мм						
			L	C	G	F	E	B	Lx
6	1/8	M6-MRT-NPT2-M6-	27.0	15.3	14	12.7	4.8	9.7	18.0
6	1/4	M6-MRT-NPT4-M6-	27.0	15.3	14	12.7	4.8	14.2	23.4
8	1/8	M8-MRT-NPT2-M8-	29.9	16.2	16	15.9	4.8	9.7	20.8
8	1/4	M8-MRT-NPT4-M8-	29.9	16.2	16	15.9	6.4	14.2	25.4
10	1/4	M10-MRT-NPT4-M10-	33.5	17.2	19	20.6	7.9	14.2	28.2
10	1/2	M10-MRT-NPT8-M10-	33.5	17.2	19	20.6	7.9	14.2	28.2
12	1/4	M12-MRT-NPT4-M12-	36.0	22.8	22	20.6	7.9	14.2	28.2
12	3/8	M12-MRT-NPT6-M12-	36.0	22.8	22	20.6	9.5	14.2	28.2
12	1/2	M12-MRT-NPT8-M12-	36.0	22.8	22	20.6	9.5	19.1	33.0
16	1/2	M16-MRT-NPT8-M16-	38.0	24.4	25	23.8	11.9	19.1	35.0

Позиционируемый тройник с внешней резьбой снизу

SAE/MS Прямая резьба

Адаптер по стандартам

SAE J1926-1, ISO 11926-1 и MS 16142

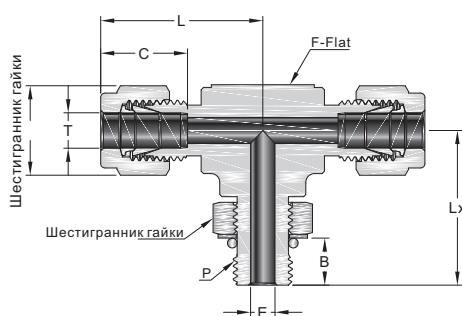

Дюймовая трубка

Резьба SAE/MS

Трубка, дюйм	P-SAE/MS Размер резьбы	Артикул для заказа	Габариты, мм							
			L	B	C	E	G	F	Lx	Gx
1/4	7/16-20	F4-PMBT-F4-PST7-	28.5	9.9	15.2	4.8	14.3	12.7	28.5	14.3
3/8	9/16-18	F6-PMBT-F6-PST9-	32.0	11.2	16.8	7.1	17.5	15.9	32.3	17.5
1/2	3/4-16	F8-PMBT-F8-PST12-	37.6	12.7	22.9	10.4	22.2	20.6	37.8	22.2
3/4	1 1/16-12	F12-PMBT-F12-PST17-	41.4	16.8	24.4	15.7	28.6	27.0	48.8	28.6
1	1 5/16-12	F16-PMBT-F16-PST21-	50.5	16.8	31.2	22.4	38.1	34.9	53.6	38.1
1 1/4	1 5/8-12	F20-PMBT-F20-PST26-	67.8	16.8	41.1	27.7	47.6	42.9	58.2	47.6
1 1/4	1 7/8-12	F24-PMBT-F24-PST30-	78.0	16.8	50.0	34.0	57.2	50.8	60.5	54.0

Позиционируемый тройник с внешней резьбой снизу

ISO Цилиндрическая резьба

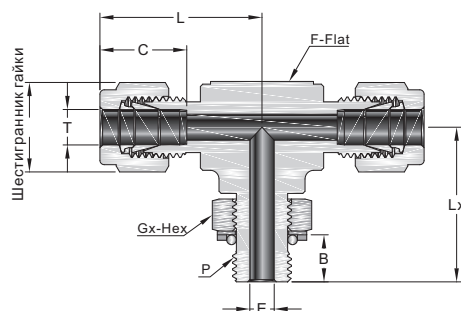

Дюймовая трубка

ISO Цилиндрическая резьба (PPT)

Трубка, дюйм	P-ISO Размер цилиндрической резьбы	Артикул для заказа	Габариты, мм							
			L	B	C	E	G	F	Lx	Gx
1/4	1/8	F4-PMBT-F4-PPT2-	26.9	8.1	15.2	4.1	14.3	12.7	26.4	14.3
1/4	1/4	F4-PMBT-F4-PPT4-	29.0	9.1	15.2	4.8	14.3	15.9	32.3	19.1
3/8	1/4	F6-PMBT-F6-PPT4-	30.5	9.1	16.8	5.8	17.5	15.9	32.3	19.1
1/2	3/8	F8-PMBT-F8-PPT6-	36.1	9.4	22.9	7.9	22.2	20.6	37.1	22.2
1/2	1/2	F8-PMBT-F8-PPT8-	38.1	13.0	22.9	10.4	22.2	23.8	43.4	27.0
5/8	1/2	F10-PMBT-F10-PPT8-	38.1	13.0	24.4	11.9	25.4	23.8	43.4	27.0
3/4	1/2	F12-PMBT-F12-PPT8-	39.9	13.0	24.4	11.9	28.6	27.0	45.2	27.0
3/4	3/4	F12-PMBT-F12-PPT12-	39.9	13.0	24.4	15.7	28.6	27.0	48.8	34.9
1	1	F16-PMBT-F16-PPT16-	49.0	14.0	31.2	19.8	38.1	34.9	53.6	41.3

Метрическая трубка

ISO Цилиндрическая резьба (PPT)

Трубка, мм	P-ISO Размер цилиндрической резьбы	Артикул для заказа	Габариты, мм							
			L	B	C	E	G	F	Lx	Gx
6	1/8	M6-PMBT-M6-PPT2-	27.0	8.1	15.3	4.0	14	12.7	26.4	14.3
6	1/4	M6-PMBT-M6-PPT4-	29.0	9.1	15.3	4.8	14	15.9	32.2	19.1
8	1/8	M8-PMBT-M8-PPT2-	28.8	8.1	16.2	4.0	16	14.3	27.5	14.3
8	1/4	M8-PMBT-M8-PPT4-	29.9	9.1	16.2	5.9	16	15.9	32.2	19.1
10	1/4	M10-PMBT-M10-PPT4-	33.5	9.1	17.2	5.9	19	20.6	35.1	19.1
12	3/8	M12-PMBT-M12-PPT6-	36.0	9.4	22.8	7.9	22	20.6	37.1	22.2
12	1/2	M12-PMBT-M12-PPT8-	38.0	13.0	22.8	9.5	22	23.8	43.5	27.0

Позиционируемый тройник с внешней резьбой сбоку

Резьба прямая SAE/MS

Адаптер по стандартам

SAE J1926-1, ISO 11926-1 и MS 16142

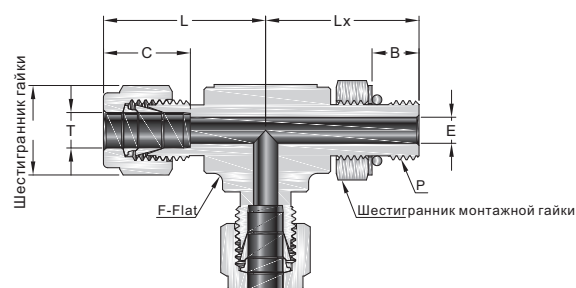

Дюймовая трубка

SAE/MS Прямая резьба

Трубка, дюйм	P-SAE/MS Размер резьбы	Артикул для заказа	Габариты, мм							
			L	B	C	E	G	F	Lx	Gx
1/4	7/16-20	F4-PMRT-PST7-F4-	28.5	9.9	15.2	4.8	14.3	12.7	28.5	14.3
3/8	9/16-18	F6-PMRT-PST9-F6-	32.0	11.2	16.8	7.1	17.5	15.9	32.3	17.5
1/2	3/4-16	F8-PMRT-PST12-F8-	37.6	12.7	22.9	10.4	22.2	20.6	37.8	22.2
3/4	1 1/16-12	F12-PMRT-PST17-F12-	41.4	16.8	24.4	15.7	28.6	27.0	48.8	28.6
1	1 5/16-12	F16-PMRT-PST21-F16-	50.5	16.8	31.2	22.4	38.1	34.9	53.6	38.1
1 1/4	1 5/8-12	F20-PMRT-PST26-F20-	67.8	16.8	41.1	27.7	47.6	42.9	58.2	47.6
1 1/2	1 7/8-12	F24-PMRT-PST30-F24-	78.0	16.8	50.0	34.0	57.2	50.8	60.5	54.0

Позиционируемый тройник с внешней резьбой сбоку

ISO Цилиндрическая резьба

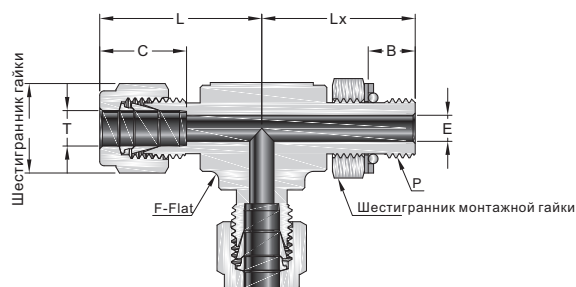

Дюймовая трубка

ISO Цилиндрическая резьба (PPT)

Трубка, дюйм	P-ISO Размер цилиндрической резьбы	Артикул для заказа	Габариты, мм							
			L	B	C	E	G	F	Lx	Gx
1/4	1/8	F4-PMRT-PPT2-F4-	26.9	8.1	15.2	4.1	14.3	12.7	26.4	14.3
1/4	1/4	F4-PMRT-PPT4-F4-	29.0	9.1	15.2	4.8	14.3	15.9	32.3	19.1
3/8	1/4	F6-PMRT-PPT4-F6-	30.5	9.1	16.8	5.8	17.5	15.9	32.3	19.1
1/2	3/8	F8-PMRT-PPT6-F8-	36.1	9.4	22.9	7.9	22.2	20.6	37.1	22.2
1/2	1/2	F8-PMRT-PPT8-F8-	38.1	13.0	22.9	10.4	22.2	23.8	43.4	27.0
5/8	1/2	F10-PMRT-PPT8-F10-	38.1	13.0	24.4	11.9	25.4	23.8	43.4	27.0
3/4	1/2	F12-PMRT-PPT8-F12-	39.9	13.0	24.4	11.9	28.6	27.0	45.2	27.0
3/4	3/4	F12-PMRT-PPT12-F12-	39.9	13.0	24.4	15.7	28.6	27.0	48.8	34.9
1	1	F16-PMRT-PPT16-F16-	49.0	14.0	31.2	19.8	38.1	34.9	53.6	41.3

Метрическая трубка

ISO Цилиндрическая резьба (PPT)

Трубка, мм	P-ISO Размер цилиндрической резьбы	Артикул для заказа	Габариты, мм							
			L	B	C	E	G	F	Lx	Gx
6	1/8	M6-PMRT-PPT2-M6-	27.0	8.1	15.3	4.0	14	12.7	26.4	14.3
6	1/4	M6-PMRT-PPT4-M6-	29.0	9.1	15.3	4.8	14	15.9	32.2	19.1
8	1/8	M8-PMRT-PPT2-M8-	28.8	8.1	16.2	4.0	16	14.3	27.5	14.3
8	1/4	M8-PMRT-PPT4-M8-	29.9	9.1	16.2	5.9	16	15.9	32.2	19.1
10	1/4	M10-PMRT-PPT4-M10-	33.5	9.1	17.2	5.9	19	20.6	35.1	19.1
12	3/8	M12-PMRT-PPT6-M12-	36.0	9.4	22.8	7.9	22	20.6	37.1	22.2
12	1/2	M12-PMRT-PPT8-M12-	38.0	13.0	22.8	9.5	22	23.8	43.5	27.0

Тройник с внутренней резьбой снизу

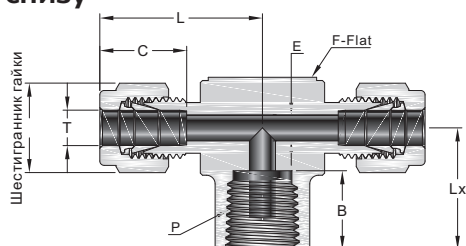

Дюймовая трубка

NPT Резьба

Трубка, дюйм	P-NPT Резьба	Артикул для заказа	Габариты, мм						
			L	C	G	F	E	B	Lx
1/8	1/8	F2-FBT-F2-FNPT2-	24.6	12.7	11.1	12.7	2.3	10.4	19.1
3/16	1/8	F3-FBT-F3-FNPT2-	25.7	13.7	12.7	12.7	3.0	10.4	19.1
1/4	1/8	F4-FBT-F4-FNPT2-	26.9	15.2	14.3	12.7	4.8	10.4	19.1
1/4	1/4	F4-FBT-F4-FNPT4-	29.7	15.2	14.3	17.5	4.8	15.0	22.4
5/16	1/8	F5-FBT-F5-FNPT2-	29.7	16.2	15.9	15.9	6.4	10.4	19.1
3/8	1/4	F6-FBT-F6-FNPT4-	31.2	16.8	17.5	17.5	7.1	15.0	22.4
3/8	3/8	F6-FBT-F6-FNPT6-	33.3	16.8	17.5	20.6	7.1	15.0	22.4
3/8	1/2	F6-FBT-F6-FNPT8-	36.1	16.8	17.5	25.4	7.1	19.8	28.4
1/2	1/4	F8-FBT-F8-FNPT4-	36.1	22.9	22.2	20.6	10.4	15.0	22.4
1/2	3/8	F8-FBT-F8-FNPT6-	36.1	22.9	22.2	20.6	10.4	15.0	22.4
1/2	1/2	F8-FBT-F8-FNPT8-	38.9	22.9	22.2	25.4	10.4	19.8	28.4
5/8	1/2	F10-FBT-F10-FNPT8-	38.9	24.4	25.4	25.4	12.7	19.8	28.4
3/4	3/4	F12-FBT-F12-FNPT12-	44.7	24.4	28.6	34.9	15.7	20.6	31.8
7/8	3/4	F14-FBT-F14-FNPT12-	44.7	25.9	31.8	34.9	18.3	20.6	31.8
1	3/4	F16-FBT-F16-FNPT12-	49.0	31.2	38.1	34.9	22.4	20.6	31.8
1	1	F16-FBT-F16-FNPT16-	53.6	31.2	38.1	42.9	22.4	25.4	38.1

Метрическая трубка

NPT Резьба

Трубка, мм	P-NPT Резьба	Артикул для заказа	Габариты, мм						
			L	C	G	F	E	B	Lx
6	1/8	M6-FBT-M6-FNPT2-	27.0	15.3	14	12.7	4.8	10.4	19.0
6	1/4	M6-FBT-M6-FNPT4-	29.8	15.3	14	17.5	4.8	15.0	22.4
8	1/8	M8-FBT-M8-FNPT2-	29.9	16.2	16	15.9	6.4	10.4	19.0
8	1/4	M8-FBT-M8-FNPT4-	30.6	16.2	16	17.5	6.4	15.0	22.4
10	1/4	M10-FBT-M10-FNPT4-	33.5	17.2	19	20.6	7.9	15.0	22.4
12	1/8	M12-FBT-M12-FNPT2-	36.0	22.8	22	20.6	6.4	10.4	22.3
12	1/4	M12-FBT-M12-FNPT4-	36.0	22.8	22	20.6	9.5	15.0	22.4
12	3/8	M12-FBT-M12-FNPT6-	36.0	22.8	22	20.6	9.5	15.0	22.4
12	1/2	M12-FBT-M12-FNPT8-	38.8	22.8	22	25.4	9.5	19.8	28.5
16	1/2	M16-FBT-M16-FNPT8-	38.8	24.4	25	25.4	12.7	19.8	28.4

Тройник с внутренней резьбой сбоку

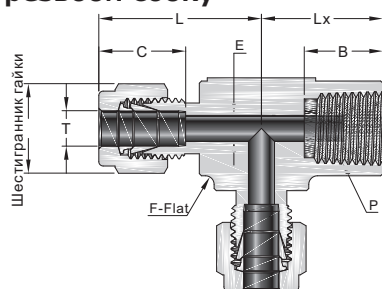

Дюймовая трубка

NPT Резьба

Трубка, дюйм	P-NPT Резьба	Артикул для заказа	Габариты, мм						
			L	C	G	F	E	B	Lx
1/8	1/8	F2-FRT-FNPT2-F2-	24.6	12.7	11.1	12.7	2.3	10.4	19.1
3/16	1/8	F3-FRT-FNPT2-F3-	25.7	13.7	12.7	12.7	3.0	10.4	19.1
1/4	1/8	F4-FRT-FNPT2-F4-	26.9	15.2	14.3	12.7	4.8	10.4	19.1
1/4	1/4	F4-FRT-FNPT4-F4-	29.7	15.2	14.3	17.5	4.8	15.0	22.4
5/16	1/8	F5-FRT-FNPT2-F5-	29.7	16.2	15.9	15.9	6.4	10.4	19.1
3/8	1/4	F6-FRT-FNPT4-F6-	31.2	16.8	17.5	17.5	7.1	15.0	22.4
1/2	1/4	F8-FRT-FNPT4-F8-	36.1	22.9	22.2	20.6	10.4	15.0	22.4
1/2	3/8	F8-FRT-FNPT6-F8-	36.1	22.9	22.2	20.6	10.4	15.0	22.4
1/2	1/2	F8-FRT-FNPT8-F8-	39.9	22.9	22.2	27.0	10.4	19.8	28.4
5/8	1/2	F10-FRT-FNPT8-F10-	39.9	24.4	25.4	27.0	12.7	19.8	28.4
3/4	3/4	F12-FRT-FNPT12-F12-	44.7	24.4	28.6	34.9	15.7	20.6	31.8
7/8	1/2	F14-FRT-FNPT8-F14-	44.7	25.9	31.8	34.9	15.7	19.8	28.4
7/8	3/4	F14-FRT-FNPT12-F14-	44.7	25.9	31.8	34.9	18.3	20.6	31.8
1	3/4	F16-FRT-FNPT12-F16-	49.0	31.2	38.1	34.9	22.4	20.6	31.8
1	1	F16-FRT-FNPT16-F16-	53.6	31.2	38.1	42.9	22.4	25.4	38.1

Метрическая трубка

NPT Резьба

Трубка, мм	P-NPT Резьба	Артикул для заказа	Габариты, мм						
			L	C	G	F	E	B	Lx
6	1/8	M6-FRT-FNPT2-M6-	27.0	15.3	14	12.7	4.8	10.4	19.0
6	1/4	M6-FRT-FNPT4-M6-	29.8	15.3	14	17.5	4.8	15.0	22.4
8	1/8	M8-FRT-FNPT2-M8-	29.9	16.2	16	15.9	4.8	10.4	19.0
8	1/4	M8-FRT-FNPT4-M8-	30.6	16.2	16	17.5	6.4	15.0	22.4
10	1/4	M10-FRT-FNPT4-M10-	33.5	17.2	19	20.6	7.9	15.0	22.4
12	1/4	M12-FRT-FNPT4-M12-	36.0	22.8	22	20.6	9.5	15.0	22.4
12	3/8	M12-FRT-FNPT6-M12-	36.0	22.8	22	20.6	9.5	15.0	23.1
12	1/2	M12-FRT-FNPT8-M12-	38.8	22.8	22	25.4	9.5	19.8	28.5
16	1/2	M16-FRT-FNPT8-M16-	39.8	24.4	25	27.0	11.9	19.8	28.4

Соединительный тройник

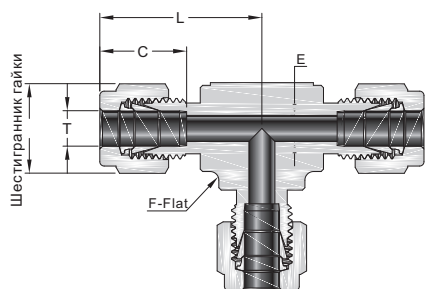

Дюймовая трубка

Трубка, дюйм	Артикул для заказа	Габариты, мм				
		L	C	G	F	E
1/16	F1-UT-F1-F1-	17.8	8.6	7.9	9.5	1.3
1/8	F2-UT-F2-F2-	22.4	12.7	11.1	9.5	2.3
3/16	F3-UT-F3-F3-	24.4	13.7	12.7	11.1	3.0
1/4	F4-UT-F4-F4-	26.9	15.2	14.3	12.7	4.8
5/16	F5-UT-F5-F5-	29.7	16.2	15.9	15.9	6.4
3/8	F6-UT-F6-F6-	30.5	16.8	17.5	15.9	7.1
1/2	F8-UT-F8-F8-	36.1	22.9	22.2	20.6	10.4
5/8	F10-UT-F10-F10-	38.9	24.4	25.4	25.4	12.7
3/4	F12-UT-F12-F12-	39.9	24.4	28.6	27.0	15.7
7/8	F14-UT-F14-F14-	44.7	25.9	31.8	34.9	18.3
1	F16-UT-F16-F16-	49.0	31.2	38.1	34.9	22.4
1 1/8	F18-UT-F18-F18-	55.1	31.2	46.0	42.9	24.6
1 1/4	F20-UT-F20-F20-	66.5	41.1	47.6	42.9	27.7
1 1/2	F24-UT-F24-F24-	78.0	50.0	57.2	50.8	34.0

Метрическая трубка

Трубка, мм	Артикул для заказа	Габариты, мм				
		L	C	G	F	E
2	M2-UT-M2-M2-	22.3	12.9	12	9.5	1.7
3	M3-UT-M3-M3-	22.3	12.9	12	9.5	2.4
4	M4-UT-M4-M4-	25.4	13.7	12	12.7	2.4
6	M6-UT-M6-M6-	27.0	15.3	14	12.7	4.8
8	M8-UT-M8-M8-	29.9	16.2	16	15.9	6.4
10	M10-UT-M10-M10-	31.5	17.2	19	17.5	7.9
12	M12-UT-M12-M12-	36.0	22.8	22	20.6	9.5
14	M14-UT-M14-M14-	38.8	24.4	25	25.4	11.1
15	M15-UT-M15-M15-	38.8	24.4	25	25.4	11.9
16	M16-UT-M16-M16-	38.8	24.4	25	25.4	12.7
18	M18-UT-M18-M18-	38.8	24.4	30	27.0	15.1
20	M20-UT-M20-M20-	44.6	26.0	32	34.9	15.9
22	M22-UT-M22-M22-	44.6	26.0	32	34.9	18.3
25	M25-UT-M25-M25-	49.1	31.3	38	34.9	21.8
28	M28-UT-M28-M28-	64.0	36.6	46	42.9	21.8
30	M30-UT-M30-M30-	69.9	39.6	50	42.9	26.2
32	M32-UT-M32-M32-	72.3	42.0	50	42.9	28.6
38	M38-UT-M38-M38-	84.0	49.4	60	50.8	33.7

Переходной соединительный тройник

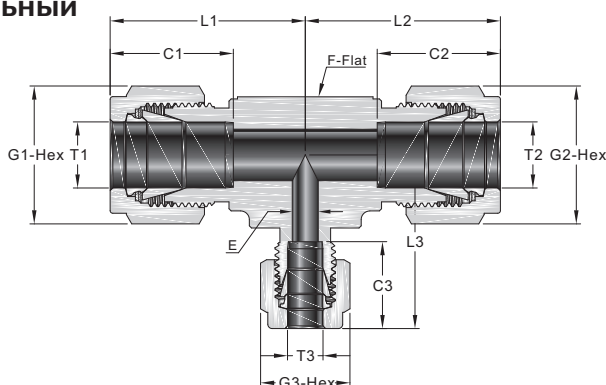

Дюймовая трубка

T1 Трубка, дюйм	T2 Трубка, дюйм	T3 Трубка, дюйм	Артикул для заказа	Габариты, мм										
				L1	L2	L3	C1	C2	C3	G1	G2	G3	F	E
1/4	1/4	1/8	F4-UT-F4-F2-	26.7	26.7	24.4	15.2	15.2	12.7	14.3	14.3	11.1	12.7	2.3
3/8	1/4	1/4	F6-UT-F4-F4-	30.5	29.0	29.0	16.8	15.2	15.2	17.5	14.3	14.3	15.9	4.8
3/8	1/4	3/8	F6-UT-F4-F6-	30.5	29.0	30.5	16.8	15.2	16.8	17.5	14.3	17.5	15.9	4.8
3/8	3/8	1/4	F6-UT-F6-F4-	30.5	30.5	29.0	16.8	16.8	15.2	17.5	17.5	14.3	15.9	4.8
1/2	1/4	1/4	F8-UT-F4-F4-	36.1	31.8	31.8	22.9	15.2	15.2	22.2	14.3	14.3	20.6	4.8
1/2	1/4	1/2	F8-UT-F4-F8-	36.1	31.8	36.1	22.9	15.2	22.9	22.2	14.3	22.2	20.6	4.8
1/2	3/8	3/8	F8-UT-F6-F6-	36.1	33.3	33.3	22.9	16.8	16.8	22.2	17.5	17.5	20.6	7.1
1/2	3/8	1/2	F8-UT-F6-F8-	36.1	33.3	36.1	22.9	16.8	22.9	22.2	17.5	22.2	20.6	7.1
1/2	1/2	1/4	F8-UT-F8-F4-	36.1	36.1	31.8	22.9	22.9	15.2	22.2	22.2	14.3	20.6	4.8
1/2	1/2	3/8	F8-UT-F8-F6-	36.1	36.1	33.3	22.9	22.9	16.8	22.2	22.2	17.5	20.6	7.1
5/8	3/8	3/8	F10-UT-F6-F6-	38.9	36.1	36.1	24.4	16.8	16.8	25.4	17.5	17.5	25.4	7.1
5/8	3/8	1/2	F10-UT-F6-F8-	38.9	36.1	38.9	24.4	16.8	22.9	25.4	17.5	22.2	25.4	7.1
5/8	1/2	3/8	F10-UT-F8-F6-	38.9	38.9	36.1	24.4	22.9	16.8	25.4	22.2	17.5	25.4	7.1
5/8	1/2	1/2	F10-UT-F8-F8-	38.9	38.9	38.9	24.4	22.9	22.9	25.4	22.2	22.2	25.4	10.4
5/8	5/8	3/8	F10-UT-F10-F6-	38.9	38.9	36.1	24.4	24.4	16.8	25.4	25.4	17.5	25.4	7.1
5/8	5/8	1/2	F10-UT-F10-F8-	38.9	38.9	38.9	24.4	24.4	22.9	25.4	25.4	22.2	25.4	10.4
3/4	3/8	3/8	F12-UT-F6-F6-	39.6	36.9	36.9	24.4	16.8	16.8	28.6	17.5	17.5	27.0	7.1
3/4	1/2	3/8	F12-UT-F8-F6-	39.6	39.6	36.9	24.4	22.9	16.8	28.6	22.2	17.5	27.0	7.1
3/4	1/2	1/2	F12-UT-F8-F8-	39.6	39.6	39.6	24.4	22.9	22.9	28.6	22.2	22.2	27.0	10.4
3/4	5/8	3/8	F12-UT-F10-F6-	39.6	39.6	36.9	24.4	24.4	16.8	28.6	25.4	17.5	27.0	7.1
3/4	5/8	1/2	F12-UT-F10-F8-	39.6	39.6	39.6	24.4	24.4	22.9	28.6	25.4	22.2	27.0	10.4
3/4	5/8	5/8	F12-UT-F10-F10-	39.6	39.6	39.6	24.4	24.4	24.4	28.6	25.4	25.4	27.0	12.7
3/4	3/4	1/4	F12-UT-F12-F4-	39.6	39.6	35.1	24.4	24.4	15.2	28.6	28.6	14.3	27.0	4.8
3/4	3/4	3/8	F12-UT-F12-F6-	39.6	39.6	36.9	24.4	24.4	16.8	28.6	28.6	17.5	27.0	7.1
3/4	3/4	1/2	F12-UT-F12-F8-	39.6	39.6	39.6	24.4	24.4	22.9	28.6	28.6	22.2	27.0	10.4
3/4	3/4	5/8	F12-UT-F12-F10-	39.6	39.6	39.6	24.4	24.4	24.4	28.6	28.6	25.4	27.0	12.7
7/8	1/2	3/4	F14-UT-F8-F12-	44.7	44.7	44.7	25.9	22.9	24.4	31.8	22.2	28.6	34.9	10.4
7/8	5/8	3/8	F14-UT-F10-F6-	44.7	44.7	41.9	25.9	24.4	16.8	31.8	25.4	17.5	34.9	7.1
7/8	3/4	3/8	F14-UT-F12-F6-	44.7	44.7	41.9	25.9	24.4	16.8	31.8	28.6	17.5	34.9	7.1
7/8	3/4	1/2	F14-UT-F12-F8-	44.7	44.7	44.7	25.9	24.4	22.9	31.8	28.6	22.2	34.9	10.4
7/8	3/4	3/4	F14-UT-F12-F12-	44.7	44.7	44.7	25.9	24.4	24.4	31.8	28.6	28.6	34.9	15.7
7/8	7/8	1/4	F14-UT-F14-F4-	44.7	44.7	40.4	25.9	25.9	15.2	31.8	31.8	14.3	34.9	4.8
7/8	7/8	3/8	F14-UT-F14-F6-	44.7	44.7	41.9	25.9	25.9	16.8	31.8	31.8	17.5	34.9	7.1
1	3/8	3/8	F16-UT-F6-F6-	49.3	41.9	41.9	31.2	16.8	16.8	38.1	17.5	17.5	34.9	7.1
1	1/2	1/4	F16-UT-F8-F4-	49.3	44.7	40.4	31.2	22.9	15.2	38.1	22.2	14.3	34.9	4.8
1	1/2	3/8	F16-UT-F8-F6-	49.3	44.7	41.9	31.2	22.9	16.8	38.1	22.2	17.5	34.9	7.1
1	1/2	1/2	F16-UT-F8-F8-	49.3	44.7	44.7	31.2	22.9	22.9	38.1	22.2	22.2	34.9	10.4
1	1/2	1	F16-UT-F8-F16-	49.3	44.7	49.3	31.2	22.9	31.2	38.1	22.2	38.1	34.9	10.4
1	5/8	3/8	F16-UT-F10-F6-	49.3	44.7	41.9	31.2	24.4	16.8	38.1	25.4	17.5	34.9	7.1
1	3/4	3/8	F16-UT-F12-F6-	49.3	44.7	41.9	31.2	24.4	16.8	38.1	28.6	17.5	34.9	7.1
1	3/4	1/2	F16-UT-F12-F8-	49.3	44.7	44.7	31.2	24.4	22.9	38.1	28.6	22.2	34.9	10.4
1	3/4	5/8	F16-UT-F12-F10-	49.3	44.7	44.7	31.2	24.4	24.4	38.1	28.6	25.4	34.9	12.7
1	3/4	1	F16-UT-F12-F16-	49.3	44.7	49.3	31.2	24.4	31.2	38.1	28.6	38.1	34.9	15.7
1	7/8	1/4	F16-UT-F14-F4-	49.3	44.7	40.4	31.2	25.9	15.2	38.1	31.8	14.3	34.9	4.8
1	7/8	3/8	F16-UT-F14-F6-	49.3	44.7	41.9	31.2	25.9	16.8	38.1	31.8	17.5	34.9	7.1
1	7/8	1/2	F16-UT-F14-F8-	49.3	44.7	44.7	31.2	25.9	22.9	38.1	31.8	22.2	34.9	10.4
1	7/8	3/4	F16-UT-F14-F12-	49.3	44.7	44.7	31.2	25.9	24.4	38.1	31.8	28.6	34.9	12.7
1	7/8	7/8	F16-UT-F14-F14-	49.3	44.7	44.7	31.2	25.9	25.9	38.1	31.8	31.8	34.9	18.3
1	1	1/4	F16-UT-F16-F4-	49.3	49.3	40.4	31.2	31.2	15.2	38.1	38.1	14.3	34.9	4.8
1	1	3/8	F16-UT-F16-F6-	49.3	49.3	41.9	31.2	31.2	16.8	38.1	38.1	17.5	34.9	7.1
1	1	1/2	F16-UT-F16-F8-	49.3	49.3	44.7	31.2	31.2	22.9	38.1	38.1	22.2	34.9	10.4
1	1	5/8	F16-UT-F16-F10-	49.3	49.3	44.7	31.2	31.2	24.4	38.1	38.1	25.4	34.9	12.7
1	1	3/4	F16-UT-F16-F12-	49.3	49.3	44.7	31.2	31.2	24.4	38.1	38.1	28.6	34.9	15.7
1	1	7/8	F16-UT-F16-F14-	49.3	49.3	44.7	31.2	31.2	25.9	38.1	38.1	31.8	34.9	18.3
1 1/4	1 1/4	1	F20-UT-F20-F16-	67.8	67.8	55.1	41.2	41.2	31.3	47.6	47.6	38.1	42.9	22.4
1 1/2	1 1/2	1	F24-UT-F24-F16-	78.7	78.7	60.0	50.0	50.0	31.3	57.2	57.2	38.1	50.8	22.4

Переходной соединительный тройник

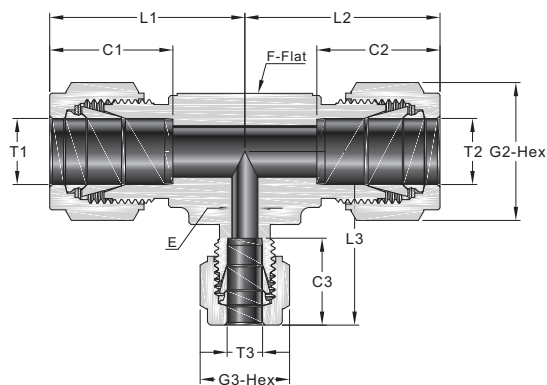

Метрическая трубка

T1 Трубка, дюйм	T2 Трубка, дюйм	T3 Трубка, дюйм	Артикул для заказа	Габариты, мм										
				L1	L2	L3	C1	C2	C3	G1	G2	G3	F	E
3	3	6	M3-UT-M3-M6-	24.7	24.7	27.0	12.9	12.9	15.3	12	12	14	12.7	2.4
6	6	3	M6-UT-M6-M3-	27.0	27.0	25.4	15.3	15.3	12.9	14	14	12	12.7	2.4
6	6	8	M6-UT-M6-M8-	28.0	28.0	28.8	15.3	15.3	16.2	14	14	16	14.3	4.8
8	8	6	M8-UT-M8-M6-	30.0	30.0	29.0	16.2	16.2	15.3	16	16	14	15.9	4.8
8	8	12	M8-UT-M8-M12-	35.2	35.2	36.0	16.2	16.2	22.8	16	16	22	20.6	6.4
10	10	6	M10-UT-M10-M6-	31.5	31.5	29.9	17.2	17.2	15.3	19	19	14	17.5	4.8
10	10	8	M10-UT-M10-M8-	31.5	31.5	30.7	17.2	17.2	16.2	19	19	16	17.5	6.4
12	12	6	M12-UT-M12-M6-	36.0	36.0	31.8	22.8	22.8	15.3	22	22	14	20.6	4.8
12	12	8	M12-UT-M12-M8-	36.0	36.0	35.2	22.8	22.8	16.2	22	22	16	20.6	6.4
12	12	14	M12-UT-M12-M14-	38.0	38.0	38.0	22.8	22.8	24.4	22	22	25	25.4	9.5
12	12	18	M12-UT-M12-M18-	39.8	39.8	39.8	22.8	22.8	24.4	22	22	30	27.0	9.5
14	14	8	M14-UT-M14-M8-	38.0	38.0	37.2	24.4	24.4	16.2	25	25	16	25.4	6.4
14	14	10	M14-UT-M14-M10-	38.0	38.0	38.0	24.4	24.4	17.2	25	25	19	25.4	7.9
15	15	12	M15-UT-M15-M12-	38.8	38.8	38.8	24.4	24.4	22.8	25	25	22	25.4	9.5
16	16	8	M16-UT-M16-M8-	38.8	37.2	38.8	24.4	16.2	24.4	25	16	25	25.4	6.4
16	16	12	M16-UT-M16-M12-	38.8	38.8	38.9	24.4	24.4	22.8	25	25	22	25.4	9.5
18	18	8	M18-UT-M18-M8-	39.8	39.8	39.0	24.4	24.4	16.2	30	30	16	27.0	6.4
18	18	10	M18-UT-M18-M10-	39.8	39.8	39.8	24.4	24.4	17.2	30	30	19	27.0	7.9
18	18	12	M18-UT-M18-M12-	39.8	39.8	39.8	24.4	24.4	22.8	30	30	22	27.0	9.5
18	18	14	M18-UT-M18-M14-	39.8	39.8	39.8	24.4	24.4	24.4	30	30	25	27.0	11.1
20	20	14	M20-UT-M20-M14-	44.6	44.6	44.6	26.0	26.0	24.4	32	32	25	34.9	11.1
22	22	12	M22-UT-M22-M12-	44.6	44.6	44.6	26.0	26.0	22.8	32	32	22	34.9	9.5
25	25	12	M25-UT-M25-M12-	49.1	49.1	44.7	31.3	31.3	22.8	38	38	22	34.9	9.5

Соединительная крестовина

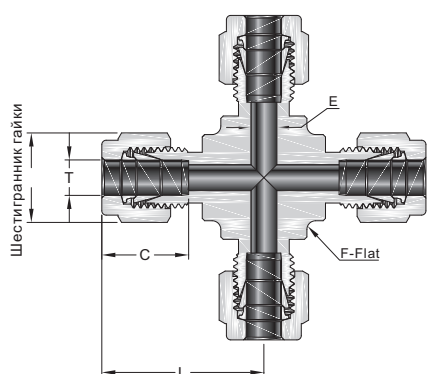

Дюймовая трубка

Трубка, дюйм	Артикул для заказа	Габариты, мм				
		L	C	G	F	E
1/8	F2-UC-F2-F2-F2-	22.4	12.7	11.1	9.5	2.3
3/16	F3-UC-F3-F3-F3-	24.4	13.7	12.7	11.1	3.0
1/4	F4-UC-F4-F4-F4-	26.9	15.2	14.3	12.7	4.8
5/16	F5-UC-F5-F5-F5-	29.7	16.2	15.9	15.9	6.4
3/8	F6-UC-F6-F6-F6-	30.5	16.8	17.5	15.9	7.1
1/2	F8-UC-F8-F8-F8-	36.1	22.9	22.2	20.6	10.4
5/8	F10-UC-F10-F10-F10-	36.3	24.4	25.4	27.0	12.7
3/4	F12-UC-F12-F12-F12-	39.9	24.4	28.6	27.0	15.7
7/8	F14-UC-F14-F14-F14-	44.7	25.9	31.8	34.9	18.3
1	F16-UC-F16-F16-F16-	49.0	31.2	38.1	34.9	22.4

Метрическая трубка

Трубка, мм	Артикул для заказа	Габариты, мм				
		L	C	G	F	E
3	M3-UC-M3-M3-M3-	22.3	12.9	12	9.5	2.4
4	M4-UC-M4-M4-M4-	25.4	13.7	12	12.7	2.4
6	M6-UC-M6-M6-M6-	27.0	15.3	14	12.7	4.8
8	M8-UC-M8-M8-M8-	29.9	16.2	16	15.9	6.4
10	M10-UC-M10-M10-M10-	33.5	17.2	19	20.6	7.9
12	M12-UC-M12-M12-M12-	36.0	22.8	22	20.6	9.5
16	M16-UC-M16-M16-M16-	37.0	24.4	25	23.8	12.7
18	M18-UC-M18-M18-M18-	38.3	24.4	30	27.0	15.1
20	M20-UC-M20-M20-M20-	44.6	26.0	32	34.9	15.9
22	M22-UC-M22-M22-M22-	44.7	26.0	32	34.9	18.3
25	M25-UC-M25-M25-M25-	49.2	31.3	38	34.9	21.8

Колпак

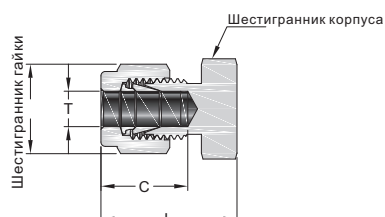

Дюймовая трубка

Трубка, дюйм	Артикул для заказа	Габариты, мм			
		L	C	G	F
1/16	CA-F1-	15.0	8.6	7.9	7.9
1/8	CA-F2-	20.1	12.7	11.1	11.1
3/16	CA-F3-	21.3	13.7	12.7	11.1
1/4	CA-F4-	23.4	15.2	14.3	12.7
5/16	CA-F5-	24.4	16.3	15.9	14.3
3/8	CA-F6-	25.7	16.8	17.5	15.9
1/2	CA-F8-	29.2	22.9	22.2	20.6
5/8	CA-F10-	30.0	24.4	25.4	23.8
3/4	CA-F12-	31.5	24.4	28.6	27.0
7/8	CA-F14-	34.0	25.9	31.8	30.2
1	CA-F16-	38.4	31.2	38.1	34.9
1 1/8	CA-F18-	38.4	31.2	46.0	41.3
1 1/4	CA-F20-	53.3	41.1	47.6	44.5
1 1/2	CA-F24-	64.5	50.0	57.2	54.0

Метрическая трубка

Трубка, мм	Артикул для заказа	Габариты, мм			
		L	C	G	F
2	CA-M2-	20.1	12.9	12	12
3	CA-M3-	20.1	12.9	12	12
4	CA-M4-	21.3	13.7	12	12
6	CA-M6-	23.1	15.3	14	14
8	CA-M8-	24.5	16.2	16	15
10	CA-M10-	26.6	17.2	19	18
12	CA-M12-	29.1	22.8	22	22
14	CA-M14-	29.9	24.4	25	24
15	CA-M15-	29.9	24.4	25	24
16	CA-M16-	29.9	24.4	25	24
18	CA-M18-	31.4	24.4	30	27
20	CA-M20-	34.0	26.0	32	30
22	CA-M22-	34.0	26.0	32	30
25	CA-M25-	38.5	31.3	38	35
28	CA-M28-	48.5	36.6	46	41
30	CA-M30-	53.4	39.6	50	46
32	CA-M32-	55.8	42.0	50	46
38	CA-M38-	65.4	49.4	60	55

Заглушка

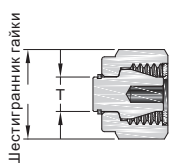

Дюймовая трубка

Трубка, дюйм	Артикул для заказа	Габариты, мм
		G
1/16	PL-F1-	7.9
1/8	PL-F2-	11.1
3/16	PL-F3-	12.7
1/4	PL-F4-	14.3
5/16	PL-F5-	15.9
3/8	PL-F6-	17.5
1/2	PL-F8-	22.2
5/8	PL-F10-	25.4
3/4	PL-F12-	28.6
7/8	PL-F14-	31.8
1	PL-F16-	38.1
1 1/4	PL-F20-	47.6
1 1/2	PL-F24-	57.2

Метрическая трубка

Трубка, мм	Артикул для заказа	Габариты, мм
		G
2	PL-M2-	12
3	PL-M3-	12
4	PL-M4-	12
6	PL-M6-	14
8	PL-M8-	16
10	PL-M10-	19
12	PL-M12-	22
14	PL-M14-	25
15	PL-M15-	25
16	PL-M16-	25
18	PL-M18-	30
20	PL-M20-	32
22	PL-M22-	32
25	PL-M25-	38
28	PL-M28-	46
30	PL-M30-	50
32	PL-M32-	50
38	PL-M38-	60

Переходники с трубным адаптером

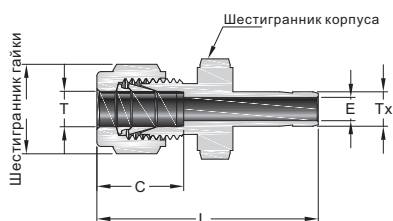

Метрическая трубка

Трубка, мм	Tx Трубка, мм	Артикул для заказа	Габариты, мм				
			L	C	G	F	E
2	3	M2-R-MT3-	33.5	12.9	12	12	1.7
3	4	M3-R-MT4-	35.0	12.9	12	12	2.4
3	6	M3-R-MT6-	36.1	12.9	12	12	2.4
3	10	M3-R-MT10-	38.4	12.9	12	14	2.4
4	6	M4-R-MT6-	37.1	13.7	12	12	2.4
6	3	M6-R-MT3-	36.9	15.3	14	14	1.9
6	8	M6-R-MT8-	39.9	15.3	14	14	4.8
6	10	M6-R-MT10-	40.7	15.3	14	14	4.8
6	12	M6-R-MT12-	46.3	15.3	14	14	4.8
6	18	M6-R-MT18-	49.6	15.3	14	22	4.8
8	6	M8-R-MT6-	40.3	16.2	16	15	4.1
8	10	M8-R-MT10-	42.0	16.2	16	15	6.4
8	12	M8-R-MT12-	47.6	16.2	16	15	6.4
10	6	M10-R-MT6-	42.4	17.2	19	18	4.1
10	8	M10-R-MT8-	43.4	17.2	19	18	5.6
10	12	M10-R-MT12-	49.8	17.2	19	18	7.9
10	15	M10-R-MT15-	51.3	17.2	19	18	7.9
10	18	M10-R-MT18-	51.3	17.2	19	22	7.9
12	6	M12-R-MT6-	44.9	22.8	22	22	4.1
12	8	M12-R-MT8-	45.9	22.8	22	22	5.6
12	10	M12-R-MT10-	46.7	22.8	22	22	7.1
12	16	M12-R-MT16-	53.8	22.8	22	22	9.5
12	18	M12-R-MT18-	53.8	22.8	22	22	9.5
12	20	M12-R-MT20-	56.1	22.8	22	22	9.5
12	22	M12-R-MT22-	56.1	22.8	22	24	9.5
12	25	M12-R-MT25-	62.4	22.8	22	27	9.5
16	12	M16-R-MT12-	53.0	24.4	25	24	8.8
18	12	M18-R-MT12-	54.6	24.4	30	27	8.8
18	16	M18-R-MT16-	56.1	24.4	30	27	12.0
18	20	M18-R-MT20-	57.6	24.4	30	27	15.1
18	22	M18-R-MT22-	57.6	24.4	30	27	15.1
18	25	M18-R-MT25-	62.4	24.4	30	27	15.1
20	16	M20-R-MT16-	57.9	26.0	32	30	12.0
20	18	M20-R-MT18-	57.9	26.0	32	30	13.9
20	22	M20-R-MT22-	59.4	26.0	32	30	15.9
20	25	M20-R-MT25-	64.2	26.0	32	30	15.8
22	18	M22-R-MT18-	57.9	26.0	32	30	13.9
22	20	M22-R-MT20-	59.4	26.0	32	30	15.5
22	25	M22-R-MT25-	64.2	26.0	32	30	18.3
25	18	M25-R-MT18-	63.1	31.3	38	35	13.9
25	20	M25-R-MT20-	64.6	31.3	38	35	15.5

Переходники с трубным адаптером

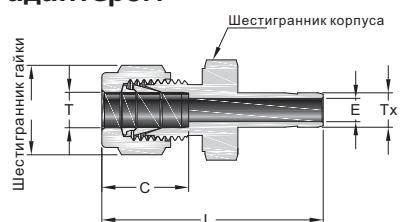

Метрическая трубка

Дюймовая трубка

Трубка, мм	Tx Трубка, дюйм	Артикул для заказа	Габариты, мм				
			L	C	G	F	E
2	1/8	M2-R-FT2-	33.5	12.9	12	12	1.7
3	1/8	M3-R-FT2-	33.5	12.9	12	12	2.0
3	1/4	M3-R-FT4-	36.1	12.9	12	12	2.4
4	1/4	M4-R-FT4-	37.1	13.7	12	12	2.4
6	1/8	M6-R-FT2-	36.9	15.3	14	14	2.0
6	1/4	M6-R-FT4-	39.2	15.3	14	14	4.4
6	5/16	M6-R-FT5-	39.9	15.3	14	14	4.8
6	3/8	M6-R-FT6-	40.7	15.3	14	14	4.8
6	1/2	M6-R-FT8-	46.3	15.3	14	14	4.8
8	1/4	M8-R-FT4-	40.3	16.2	16	15	4.4
8	3/8	M8-R-FT6-	42.0	16.2	16	15	6.4
8	1/2	M8-R-FT8-	47.6	16.2	16	15	6.4
10	3/8	M10-R-FT6-	44.2	17.2	19	18	6.8
10	1/2	M10-R-FT8-	49.8	17.2	19	18	7.9
12	1/2	M12-R-FT8-	52.3	22.8	22	22	9.3
12	3/4	M12-R-FT12-	53.8	22.8	22	22	9.5
18	3/4	M18-R-FT12-	56.1	24.4	30	27	14.7
18	1	M18-R-FT16-	62.4	24.4	30	27	15.1
25	1	M25-R-FT16-	69.5	31.3	38	35	20.2

Соединитель для фитингов

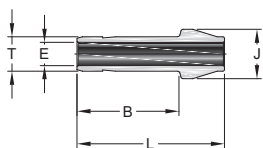

1" /25 mm and below



1 1/4" /28 mm and above

Дюймовая трубка

Трубка, дюйм	Артикул для заказа	Габариты, мм			
		L	B	E	J
1/16	PC-F1-	13.7	10.7	0.8	3.3
1/8	PC-F2-	22.4	15.7	2.0	6.1
1/4	PC-F4-	24.6	18.8	4.3	9.4
5/16	PC-F5-	25.9	20.1	5.6	10.9
3/8	PC-F6-	26.2	20.3	6.9	12.7
1/2	PC-F8-	35.8	25.9	9.4	15.7
5/8	PC-F10-	37.8	28.1	11.9	20.5
3/4	PC-F12-	37.3	27.7	14.7	22.1
1	PC-F16-	48.0	34.5	20.3	28.4
1 1/4	PC-F20-	69.1	50.6	25.9	37.4
1 1/2	PC-F24-	84.1	59.4	31.8	45.8

Метрическая трубка

Трубка, мм	Артикул для заказа	Габариты, мм			
		L	B	E	J
3	PC-M3-	22.2	15.7	1.9	6.0
6	PC-M6-	24.6	18.7	4.1	9.0
8	PC-M8-	25.9	20.0	5.6	11.0
10	PC-M10-	26.1	20.2	7.1	13.1
12	PC-M12-	35.8	26.0	8.8	15.0
15	PC-M15-	37.8	27.6	11.2	19.6
16	PC-M16-	37.8	27.6	12.0	20.6
18	PC-M18-	37.8	27.7	13.9	21.0
20	PC-M20-	39.4	29.2	15.5	24.6
25	PC-M25-	49.3	34.5	19.9	31.2
28	PC-M28-	63.5	48.3	22.5	34.4
30	PC-M30-	67.6	52.2	24.3	37.4
32	PC-M32-	69.7	52.4	26.5	39.4
38	PC-M38-	81.9	61.4	31.6	45.8

Переходной соединитель для фитингов

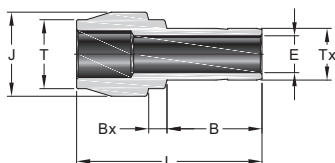

Дюймовая трубка

Трубка, мм	Тх Трубка, мм	Артикул для заказа	Габариты, мм				
			L	B	E	Bx	J
1/8	1/16	F2-PC-F1-	17.3	8.6	0.8	2.0	6.1
1/4	1/16	F4-PC-F1-	18.0	8.6	0.8	3.6	9.4
1/4	1/8	F4-PC-F2-	22.6	13.5	2.0	3.3	9.4
3/8	1/8	F6-PC-F2-	23.1	13.5	2.0	3.8	12.7
3/8	1/4	F6-PC-F4-	24.9	15.7	4.3	3.3	12.7
1/2	1/4	F8-PC-F4-	29.2	15.7	4.3	3.8	15.7
1/2	3/8	F8-PC-F6-	30.5	17.5	6.9	3.3	15.7
3/4	1/2	F12-PC-F8-	37.8	23.1	9.4	3.8	22.1
1	1/2	F16-PC-F8-	42.9	24.4	9.4	4.8	28.5
1	3/4	F16-PC-F12-	43.7	25.9	14.7	4.1	28.5

Метрическая трубка

Трубка, мм	Тх Трубка, мм	Артикул для заказа	Габариты, мм				
			L	B	E	Bx	J
6	3	M6-PC-M3-	22.6	13.5	1.9	3.2	9.0
8	6	M8-PC-M6-	24.7	15.7	4.1	3.1	11.0
10	6	M10-PC-M6-	25.0	15.7	4.1	3.4	13.1
10	8	M10-PC-M8-	26.3	17.0	5.6	3.1	13.1
12	6	M12-PC-M6-	29.6	15.7	4.1	3.6	15.0
12	8	M12-PC-M8-	29.8	16.8	5.6	3.4	15.0
12	10	M12-PC-M10-	30.4	17.5	7.1	3.1	15.0
16	12	M16-PC-M12-	36.2	23.1	8.8	3.4	19.0
28	25	M28-PC-M25-	56.5	33.0	19.8	8.2	34.3
32	25	M32-PC-M25-	60.3	33.0	19.8	9.9	39.5
38	25	M38-PC-M25-	65.8	33.0	19.8	12.3	47.1

Трубный адаптер с внешней резьбой

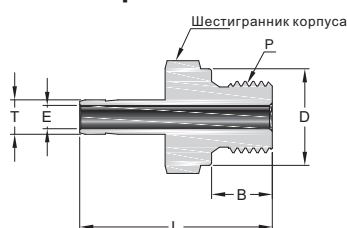

Дюймовая трубка

ISO Цилиндрическая резьба (BS)

Трубка, дюйм	P-BS Size	Артикул для заказа	Габариты, дюйм (мм)				
			L	B	E	F	D
1/8	1/8	FT2-MA-MBS2-	1.22(31.0)	0.28(7.1)	0.08(2.0)	0.56(14.3)	0.54(13.7)
1/8	1/4	FT2-MA-MBS4-	1.41(35.8)	0.44(11.2)	0.08(2.0)	0.75(19.1)	0.70(17.8)
1/4	1/8	FT4-MA-MBS2-	1.31(33.3)	0.28(7.1)	0.16(4.1)	0.56(14.3)	0.54(13.7)
1/4	1/4	FT4-MA-MBS4-	1.50(38.1)	0.44(11.2)	0.17(4.3)	0.75(19.1)	0.70(17.8)
3/8	1/8	FT6-MA-MBS2-	1.34(34.0)	0.28(7.1)	0.05(1.3)	0.56(14.3)	0.54(13.7)
3/8	1/4	FT6-MA-MBS4-	1.57(39.9)	0.44(11.2)	0.23(5.8)	0.75(19.1)	0.70(17.8)
3/8	3/8	FT6-MA-MBS6-	1.60(40.6)	0.44(11.2)	0.27(6.9)	0.87(22.2)	0.85(21.6)
3/8	1/2	FT6-MA-MBS8-	1.69(42.9)	0.56(14.2)	0.28(7.1)	1.06(27.0)	1.02(25.9)
1/2	1/4	FT8-MA-MBS4-	1.79(45.5)	0.44(11.2)	0.23(5.8)	0.75(19.1)	0.70(17.8)
1/2	3/8	FT8-MA-MBS6-	1.82(46.2)	0.44(11.2)	0.31(7.9)	0.87(22.2)	0.85(21.6)
1/2	1/2	FT8-MA-MBS8-	1.94(49.2)	0.56(14.2)	0.37(9.4)	1.06(27.0)	1.02(25.9)
5/8	1/2	FT10-MA-MBS8-	1.97(50.0)	0.56(14.2)	0.47(11.9)	1.06(27.0)	1.02(25.9)
3/4	3/4	FT12-MA-MBS12-	2.16(54.9)	0.63(16.0)	0.58(14.7)	1.31(33.3)	1.26(32.0)
1	1	FT16-MA-MBS16-	2.54(64.5)	0.72(18.3)	0.80(20.3)	1.63(41.3)	1.53(38.9)

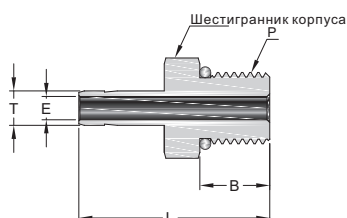
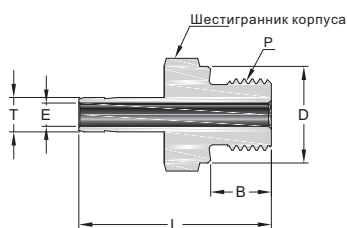

1" and below

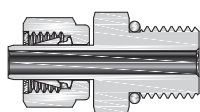

1 1/4" and above

Adapt to straight thread boss of SAE J1926-1, ISO 11926-1 and MS 16142.

Трубный адаптер с внешней резьбой

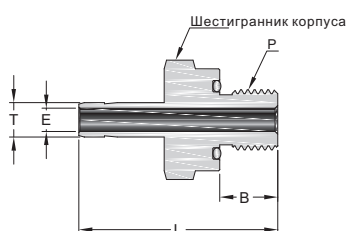
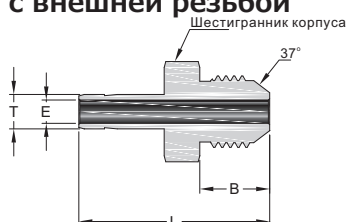

Дюймовая трубка ISO Цилиндрическая резьба (BP)

Трубка, дюйм	P-BP Size	Артикул для заказа	Габариты, дюйм (мм)				
			L	B	E	F	D
1/8	1/8	FT2-MA-PMBP2-	1.09(27.7)	0.28(7.1)	0.05(1.3)	0.56(14.3)	0.54(13.7)
1/8	1/4	FT2-MA-PMBP4-	1.31(33.3)	0.44(11.2)	0.05(1.3)	0.75(19.1)	0.70(17.8)
1/4	1/8	FT4-MA-PMBP2-	1.19(30.2)	0.28(7.1)	0.16(4.1)	0.56(14.3)	0.54(13.7)
1/4	1/4	FT4-MA-PMBP4-	1.50(38.1)	0.44(11.2)	0.18(4.6)	0.75(19.1)	0.70(17.8)
3/8	1/8	FT6-MA-PMBP2-	1.34(34.0)	0.28(7.1)	0.05(1.3)	0.75(19.1)	0.54(13.7)
3/8	1/4	FT6-MA-PMBP4-	1.47(37.3)	0.44(11.2)	0.25(6.4)	0.75(19.1)	0.70(17.8)
3/8	3/8	FT6-MA-PMBP6-	1.50(38.1)	0.44(11.2)	0.28(7.1)	0.87(22.2)	0.85(21.6)
3/8	1/2	FT6-MA-PMBP8-	1.69(42.9)	0.56(14.2)	0.28(7.1)	1.06(27.0)	1.02(25.9)
1/2	1/4	FT8-MA-PMBP4-	1.69(42.9)	0.44(11.2)	0.25(6.4)	0.75(19.1)	0.70(17.8)
1/2	3/8	FT8-MA-PMBP6-	1.72(43.7)	0.44(11.2)	0.31(7.9)	0.87(22.2)	0.85(21.6)
1/2	1/2	FT8-MA-PMBP8-	1.94(49.3)	0.56(14.2)	0.39(9.9)	1.06(27.0)	1.02(25.9)
5/8	1/2	FT10-MA-PMBP8-	1.97(50.0)	0.56(14.2)	0.47(11.9)	1.06(27.0)	1.02(25.9)
3/4	3/4	FT12-MA-PMBP12-	2.09(53.1)	0.63(16.0)	0.58(14.7)	1.32(33.5)	1.26(32.0)
1	1	FT16-MA-PMBP16-	2.49(63.3)	0.72(18.3)	0.80(20.3)	1.63(41.3)	1.53(38.9)

Дюймовая трубка SAE/MS Прямая резьба

Трубка, дюйм	P-SAE/MS Размер резьбы	Артикул для заказа	Габариты, дюйм (мм)			
			L	B	E	F
1/8	5/16-24	FT2-MA-OST5-	1.20(30.5)	0.30(7.6)	0.08(2.0)	0.44(11.1)
1/4	7/16-20	FT4-MA-OST7-	1.39(35.3)	0.36(9.1)	0.17(4.3)	0.56(14.3)
3/8	7/16-20	FT6-MA-OST7-	1.46(37.1)	0.36(9.1)	0.20(5.1)	0.56(14.3)
3/8	9/16-18	FT6-MA-OST9-	1.52(38.6)	0.39(9.9)	0.27(6.9)	0.69(17.5)
3/8	3/4-16	FT6-MA-OST12-	1.60(40.6)	0.44(11.2)	0.27(6.9)	0.87(22.2)
1/2	9/16-18	FT8-MA-OST9-	1.74(44.2)	0.39(9.9)	0.28(7.1)	0.69(17.5)
1/2	3/4-16	FT8-MA-OST12-	1.82(46.2)	0.44(11.2)	0.37(9.4)	0.87(22.2)
5/8	7/8-14	FT10-MA-OST14-	1.94(49.3)	0.50(12.7)	0.47(11.9)	1.00(25.4)
3/4	1 1/16-12	FT12-MA-OST17-	2.10(53.3)	0.59(15.0)	0.58(14.7)	1.25(31.8)
1	1 5/16-12	FT16-MA-OST21-	2.41(61.2)	0.59(15.0)	0.80(20.3)	1.50(38.1)
1 1/4	1 5/8-12	FT20-MA-OST26-	2.81(71.4)	0.59(15.0)	1.02(25.9)	1.87(47.6)
1 1/2	1 7/8-12	FT24-MA-OST30-	3.28(83.3)	0.59(15.0)	1.25(31.8)	2.13(54.0)

Дюймовая трубка 37° Flare (AN)

Трубка, дюйм	AN Tube Flare Size	Артикул для заказа	Габариты, дюйм (мм)			
			L	B	E	F
1/4	1/4	FT4-MA-AN4-	1.46(37.1)	0.55(14.0)	0.17(4.3)	0.50(12.7)
3/8	1/4	FT6-MA-AN4-	1.53(38.9)	0.55(14.0)	0.17(4.3)	0.50(12.7)
3/8	3/8	FT6-MA-AN6-	1.56(39.6)	0.56(14.2)	0.27(6.9)	0.63(15.9)
1/2	1/2	FT8-MA-AN8-	1.91(48.5)	0.66(16.8)	0.37(9.4)	0.81(20.6)
3/4	3/4	FT12-MA-AN12-	2.21(56.1)	0.86(21.8)	0.58(14.7)	1.13(28.6)
1	1	FT16-MA-AN16-	2.58(65.5)	0.91(23.1)	0.80(20.3)	1.37(34.9)

Дюймовая трубка O-Seal with SAE/MS Прямая резьба

Трубка, дюйм	P-SAE/MS Размер резьбы	Артикул для заказа	Габариты, дюйм (мм)			
			L	B	E	F
1/8	5/16-24	FT2-MA-STO5-	1.28(32.5)	0.34(8.6)	0.08(2.0)	0.56(14.3)
3/16	3/8-24	FT3-MA-STO6-	1.38(35.1)	0.38(9.7)	0.12(3.0)	0.63(15.9)
1/4	7/16-20	FT4-MA-STO7-	1.54(39.1)	0.41(10.4)	0.17(4.3)	0.75(19.1)
5/16	1/2-20	FT5-MA-STO8-	1.64(41.7)	0.44(11.2)	0.22(5.6)	0.87(22.2)
3/8	9/16-18	FT6-MA-STO9-	1.70(43.2)	0.47(11.9)	0.27(6.9)	0.94(23.8)
1/2	3/4-16	FT8-MA-STO12-	1.95(49.5)	0.47(11.9)	0.37(9.4)	1.13(28.6)

Трубный адаптер с внешней резьбой

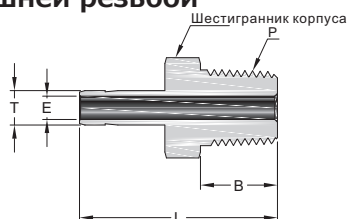

1" and below



1 1/4" and above

Дюймовая трубка

NPT Резьба

Трубка, дюйм	P-NPT Резьба	Артикул для заказа	Габариты, дюйм (мм)			
			L	B	E	F
1/16	1/8	FT1-MA-NPT2-	1.00(25.4)	0.38(9.7)	0.03(0.8)	0.44(11.1)
1/8	1/8	FT2-MA-NPT2-	1.16(29.5)	0.38(9.7)	0.08(2.0)	0.44(11.1)
1/8	1/4	FT2-MA-NPT4-	1.37(34.8)	0.56(14.2)	0.08(2.0)	0.56(14.3)
3/16	1/8	FT3-MA-NPT2-	1.19(30.2)	0.38(9.7)	0.12(3.0)	0.44(11.1)
3/16	1/4	FT3-MA-NPT4-	1.40(35.6)	0.56(14.2)	0.12(3.0)	0.56(14.3)
1/4	1/8	FT4-MA-NPT2-	1.25(31.8)	0.38(9.7)	0.17(4.3)	0.44(11.1)
1/4	1/4	FT4-MA-NPT4-	1.46(37.1)	0.56(14.2)	0.17(4.3)	0.56(14.3)
1/4	3/8	FT4-MA-NPT6-	1.49(37.8)	0.56(14.2)	0.17(4.3)	0.69(17.5)
1/4	1/2	FT4-MA-NPT8-	1.71(43.4)	0.75(19.1)	0.17(4.3)	0.87(22.2)
5/16	1/8	FT5-MA-NPT2-	1.29(32.8)	0.38(9.7)	0.19(4.8)	0.44(11.1)
5/16	1/4	FT5-MA-NPT4-	1.50(38.1)	0.56(14.2)	0.22(5.6)	0.56(14.3)
5/16	3/8	FT5-MA-NPT6-	1.53(38.9)	0.56(14.2)	0.22(5.6)	0.69(17.5)
5/16	1/2	FT5-MA-NPT8-	1.74(44.2)	0.75(19.1)	0.22(5.6)	0.87(22.2)
3/8	1/8	FT6-MA-NPT2-	1.32(33.5)	0.38(9.7)	0.19(4.8)	0.44(11.1)
3/8	1/4	FT6-MA-NPT4-	1.53(38.9)	0.56(14.2)	0.27(6.9)	0.56(14.3)
3/8	3/8	FT6-MA-NPT6-	1.56(39.6)	0.56(14.2)	0.27(6.9)	0.69(17.5)
3/8	1/2	FT6-MA-NPT8-	1.78(45.2)	0.75(19.1)	0.27(6.9)	0.87(22.2)
1/2	1/4	FT8-MA-NPT4-	1.75(44.5)	0.56(14.2)	0.28(7.1)	0.56(14.3)
1/2	3/8	FT8-MA-NPT6-	1.78(45.2)	0.56(14.2)	0.37(9.4)	0.69(17.5)
1/2	1/2	FT8-MA-NPT8-	2.00(50.8)	0.75(19.1)	0.37(9.4)	0.87(22.2)
5/8	1/2	FT10-MA-NPT8-	2.06(52.3)	0.75(19.1)	0.47(11.9)	0.87(22.2)
3/4	1/2	FT12-MA-NPT8-	2.06(52.3)	0.75(19.1)	0.47(11.9)	0.87(22.2)
3/4	3/4	FT12-MA-NPT12-	2.06(52.3)	0.75(19.1)	0.58(14.7)	1.06(27.0)
3/4	1	FT12-MA-NPT16-	2.41(61.2)	0.94(23.9)	0.81(20.7)	1.37(34.9)
1	3/4	FT16-MA-NPT12-	2.31(58.7)	0.75(19.1)	0.62(15.7)	1.06(27.0)
1	1	FT16-MA-NPT16-	2.60(66.0)	0.94(23.9)	0.80(20.3)	1.37(34.9)
1 1/4	1 1/4	FT20-MA-NPT20-	3.16(80.3)	0.94(23.9)	1.02(25.9)	1.75(44.5)
1 1/2	1 1/2	FT24-MA-NPT24-	3.72(94.5)	1.03(26.2)	1.25(31.8)	2.13(54.0)

Дюймовая трубка

ISO Коническая резьба (BSPT)

Трубка, дюйм	P-BSPT Резьба	Артикул для заказа	Габариты, дюйм (мм)			
			L	B	E	F
1/8	1/8	FT2-MA-MBT2-	1.16(29.5)	0.38(9.7)	0.08(2.0)	0.44(11.1)
1/8	1/4	FT2-MA-MBT4-	1.37(34.8)	0.56(14.2)	0.08(2.0)	0.56(14.3)
1/4	1/8	FT4-MA-MBT2-	1.25(31.8)	0.38(9.7)	0.17(4.3)	0.44(11.1)
1/4	1/4	FT4-MA-MBT4-	1.46(37.1)	0.56(14.2)	0.17(4.3)	0.56(14.3)
1/4	3/8	FT4-MA-MBT6-	1.49(37.8)	0.56(14.2)	0.17(4.3)	0.69(17.5)
1/4	1/2	FT4-MA-MBT8-	1.71(43.4)	0.75(19.1)	0.17(4.3)	0.87(22.2)
5/16	1/8	FT5-MA-MBT2-	1.29(32.8)	0.38(9.7)	0.19(4.8)	0.44(11.1)
5/16	1/4	FT5-MA-MBT4-	1.50(38.1)	0.56(14.2)	0.22(5.6)	0.56(14.3)
3/8	1/4	FT6-MA-MBT4-	1.53(38.9)	0.56(14.2)	0.27(6.9)	0.56(14.3)
3/8	3/8	FT6-MA-MBT6-	1.56(39.6)	0.56(14.2)	0.27(6.9)	0.69(17.5)
3/8	1/2	FT6-MA-MBT8-	1.78(45.2)	0.75(19.1)	0.27(6.9)	0.87(22.2)
1/2	1/4	FT8-MA-MBT4-	1.75(44.5)	0.56(14.2)	0.28(7.1)	0.56(14.3)
1/2	3/8	FT8-MA-MBT6-	1.78(45.2)	0.56(14.2)	0.37(9.4)	0.69(17.5)
1/2	1/2	FT8-MA-MBT8-	2.00(50.8)	0.75(19.1)	0.37(9.4)	0.87(22.2)
5/8	3/8	FT10-MA-MBT6-	1.91(48.5)	0.56(14.2)	0.37(9.5)	0.69(17.5)
5/8	1/2	FT10-MA-MBT8-	2.06(52.3)	0.75(19.1)	0.47(11.9)	0.87(22.2)
3/4	3/4	FT12-MA-MBT12-	2.06(52.3)	0.75(19.1)	0.58(14.7)	1.06(27.0)
1	1	FT16-MA-MBT16-	2.60(66.0)	0.94(23.9)	0.80(20.3)	1.37(34.9)

Трубный адаптер с внешней резьбой

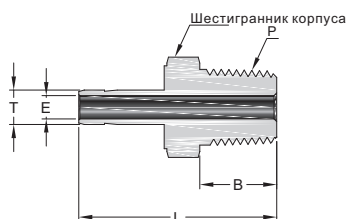

до 25 мм



от 28 мм

Метрическая трубка

NPT Резьба

Трубка, мм	P-NPT Резьба	Артикул для заказа	Габариты, мм (дюйм)			
			L	B	E	F
3	1/8	MT3-MA-NPT2-	29.4(1.16)	9.7(0.38)	1.8(0.07)	12.0(0.47)
4	1/8	MT4-MA-NPT2-	29.4(1.16)	9.7(0.38)	2.0(0.08)	12.0(0.47)
6	1/8	MT6-MA-NPT2-	32.8(1.29)	9.7(0.38)	4.1(0.16)	12.0(0.47)
6	1/4	MT6-MA-NPT4-	38.1(1.50)	14.2(0.56)	4.1(0.16)	14.0(0.55)
6	3/8	MT6-MA-NPT6-	39.2(1.54)	14.2(0.56)	4.1(0.16)	18.0(0.71)
6	1/2	MT6-MA-NPT8-	42.1(1.66)	19.1(0.75)	4.1(0.16)	22.0(0.87)
8	1/4	MT8-MA-NPT4-	39.1(1.54)	14.2(0.56)	5.6(0.22)	14.0(0.55)
8	3/8	MT8-MA-NPT6-	39.9(1.57)	14.2(0.56)	5.6(0.22)	19.0(0.75)
10	1/4	MT10-MA-NPT4-	39.9(1.57)	14.2(0.56)	7.1(0.28)	14.0(0.55)
10	3/8	MT10-MA-NPT6-	40.6(1.60)	14.2(0.56)	7.1(0.28)	18.0(0.71)
10	1/2	MT10-MA-NPT8-	46.2(1.82)	19.1(0.75)	7.1(0.28)	22.0(0.87)
12	1/4	MT12-MA-NPT4-	46.5(1.83)	14.2(0.56)	7.1(0.28)	14.0(0.55)
12	3/8	MT12-MA-NPT6-	46.2(1.82)	14.2(0.56)	8.8(0.35)	18.0(0.71)
12	1/2	MT12-MA-NPT8-	52.1(2.05)	19.1(0.75)	8.8(0.35)	22.0(0.87)
16	1/2	MT16-MA-NPT8-	50.8(2.00)	19.1(0.75)	12.7(0.50)	22.0(0.87)
16	3/4	MT16-MA-NPT12-	51.6(2.03)	19.1(0.75)	12.7(0.50)	27.0(1.06)
18	1/2	MT18-MA-NPT8-	50.8(2.00)	19.1(0.75)	12.7(0.50)	27.0(1.06)
18	3/4	MT18-MA-NPT12-	51.6(2.03)	19.1(0.75)	14.0(0.55)	27.0(1.06)
20	1/2	MT20-MA-NPT8-	51.8(2.04)	19.1(0.75)	11.9(0.47)	22.0(0.87)
20	3/4	MT20-MA-NPT12-	52.4(2.06)	19.1(0.75)	15.1(0.59)	27.0(1.06)
25	1	MT25-MA-NPT16-	65.9(2.59)	23.9(0.94)	19.8(0.78)	35.0(1.38)
28	1	MT28-MA-NPT16-	74.4(2.93)	23.9(0.94)	22.2(0.87)	35.0(1.38)
28	1 1/4	MT28-MA-NPT20-	76.2(3.00)	23.9(0.94)	22.5(0.89)	46.0(1.81)
30	1	MT30-MA-NPT16-	79.2(3.12)	23.9(0.94)	22.2(0.87)	41.0(1.61)
30	1 1/4	MT30-MA-NPT20-	80.0(3.15)	23.9(0.94)	24.3(0.96)	46.0(1.81)
32	1 1/4	MT32-MA-NPT20-	81.0(3.19)	23.9(0.94)	26.5(1.04)	46.0(1.81)
38	1 1/2	MT38-MA-NPT24-	92.2(3.63)	26.2(1.03)	31.6(1.24)	55.0(2.17)

Метрическая трубка

ISO Коническая резьба (BSPT)

Трубка, мм	P-BSPT Резьба	Артикул для заказа	Габариты, мм (дюйм)			
			L	B	E	F
3	1/8	MT3-MA-MBT2-	29.4(1.16)	9.7(0.38)	1.8(0.07)	12.0(0.47)
4	1/8	MT4-MA-MBT2-	29.4(1.16)	9.7(0.38)	2.0(0.08)	12.0(0.47)
6	1/8	MT6-MA-MBT2-	32.8(1.29)	9.7(0.38)	4.1(0.16)	12.0(0.47)
6	1/4	MT6-MA-MBT4-	38.1(1.50)	14.2(0.56)	4.1(0.16)	14.0(0.55)
8	1/4	MT8-MA-MBT4-	39.1(1.54)	14.2(0.56)	5.6(0.22)	14.0(0.55)
8	3/8	MT8-MA-MBT6-	39.9(1.57)	14.2(0.56)	5.6(0.22)	18.0(0.71)
10	1/4	MT10-MA-MBT4-	39.9(1.57)	14.2(0.56)	7.1(0.28)	14.0(0.55)
10	3/8	MT10-MA-MBT6-	40.6(1.60)	14.2(0.56)	7.1(0.28)	18.0(0.71)
10	1/2	MT10-MA-MBT8-	44.5(1.75)	19.1(0.75)	7.5(0.30)	22.0(0.87)
12	1/4	MT12-MA-MBT4-	46.5(1.83)	14.2(0.56)	7.1(0.28)	16.0(0.63)
12	3/8	MT12-MA-MBT6-	46.2(1.82)	14.2(0.56)	8.8(0.35)	18.0(0.71)
12	1/2	MT12-MA-MBT8-	51.8(2.04)	19.1(0.75)	8.8(0.35)	22.0(0.87)
16	1/2	MT16-MA-MBT8-	50.8(2.00)	19.1(0.75)	12.7(0.50)	22.0(0.87)
18	3/4	MT18-MA-MBT12-	51.6(2.03)	19.1(0.75)	14.0(0.55)	27.0(1.06)
20	3/4	MT20-MA-MBT12-	52.4(2.06)	19.1(0.75)	15.1(0.59)	27.0(1.06)
25	1	MT25-MA-MBT16-	65.9(2.59)	23.9(0.94)	19.8(0.78)	35.0(1.38)
28	1	MT28-MA-MBT16-	74.7(2.94)	23.9(0.94)	22.2(0.87)	35.0(1.38)
28	1 1/4	MT28-MA-MBT20-	76.2(3.00)	23.9(0.94)	22.5(0.89)	46.0(1.81)
30	1 1/4	MT30-MA-MBT20-	80.0(3.15)	23.9(0.94)	24.3(0.96)	46.0(1.81)
32	1 1/4	MT32-MA-MBT20-	81.0(3.19)	23.9(0.94)	26.5(1.04)	46.0(1.81)
38	1 1/2	MT38-MA-MBT24-	92.2(3.63)	26.2(1.03)	31.6(1.24)	55.0(2.17)

Трубный адаптер с внешней резьбой

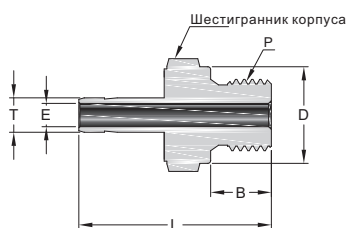

до 25 мм

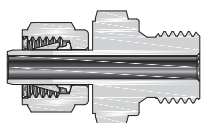

от 28 мм

Метрическая трубка

ISO Цилиндрическая резьба (BS)

Трубка, мм	P-BS Резьба	Артикул для заказа	Габариты, мм (дюйм)				
			L	B	E	F	D
3	1/8	MT3-MA-MBS2-	31.0(1.22)	7.1(0.28)	1.8(0.07)	14.0(0.55)	13.7(0.54)
4	1/8	MT4-MA-MBS2-	31.8(1.25)	7.1(0.28)	2.0(0.08)	14.0(0.55)	13.7(0.54)
6	1/8	MT6-MA-MBS2-	34.3(1.35)	7.1(0.28)	4.0(0.16)	14.0(0.55)	13.7(0.54)
6	1/4	MT6-MA-MBS4-	39.1(1.54)	11.2(0.44)	4.1(0.16)	19.0(0.75)	17.8(0.70)
8	1/4	MT8-MA-MBS4-	40.1(1.58)	11.2(0.44)	5.6(0.22)	19.0(0.75)	17.8(0.70)
10	1/4	MT10-MA-MBS4-	40.9(1.61)	11.2(0.44)	5.9(0.23)	19.0(0.75)	17.8(0.70)
10	3/8	MT10-MA-MBS6-	41.7(1.64)	11.2(0.44)	7.1(0.28)	22.0(0.87)	21.6(0.85)
10	1/2	MT10-MA-MBS8-	44.7(1.76)	14.2(0.56)	7.1(0.28)	27.0(1.06)	25.9(1.02)
12	1/4	MT12-MA-MBS4-	46.7(1.84)	11.2(0.44)	5.9(0.23)	19.0(0.75)	17.8(0.70)
12	3/8	MT12-MA-MBS6-	47.2(1.86)	11.2(0.44)	7.9(0.31)	22.0(0.87)	21.6(0.85)
12	1/2	MT12-MA-MBS8-	50.5(1.99)	14.2(0.56)	8.8(0.35)	27.0(1.06)	25.9(1.02)
16	1/2	MT16-MA-MBS8-	50.8(2.00)	14.2(0.56)	11.9(0.47)	27.0(1.06)	25.9(1.02)
18	3/4	MT18-MA-MBS12-	55.9(2.20)	16.0(0.63)	13.9(0.55)	35.0(1.38)	32.0(1.26)
20	3/4	MT20-MA-MBS12-	57.0(2.24)	16.0(0.63)	15.1(0.59)	35.0(1.38)	32.0(1.26)
25	1	MT25-MA-MBS16-	65.1(2.56)	18.3(0.72)	19.8(0.78)	41.0(1.61)	38.9(1.53)
28	1	MT28-MA-MBS16-	72.9(2.87)	18.3(0.72)	19.8(0.78)	41.0(1.61)	38.9(1.53)
28	1 1/4	MT28-MA-MBS20-	77.0(3.03)	19.8(0.78)	22.5(0.89)	50.0(1.97)	49.0(1.93)
30	1 1/4	MT30-MA-MBS20-	80.8(3.18)	19.8(0.78)	24.3(0.96)	50.0(1.97)	49.0(1.93)
32	1 1/4	MT32-MA-MBS20-	81.8(3.22)	19.8(0.78)	26.5(1.04)	50.0(1.97)	49.0(1.93)
38	1 1/2	MT38-MA-MBS24-	94.5(3.72)	22.1(0.87)	31.6(1.24)	55.0(2.17)	54.7(2.15)

Метрическая трубка

ISO Цилиндрическая резьба (BP)

Трубка, мм	P-BP Резьба	Артикул для заказа	Габариты, мм (дюйм)				
			L	B	E	F	D
3	1/8	MT3-MA-PMBP2-	31.0(1.22)	7.1(0.28)	1.8(0.07)	14.0(0.55)	13.7(0.54)
4	1/8	MT4-MA-PMBP2-	31.8(1.25)	7.1(0.28)	2.0(0.08)	14.0(0.55)	13.7(0.54)
6	1/8	MT6-MA-PMBP2-	33.3(1.31)	7.1(0.28)	4.0(0.16)	14.0(0.55)	13.7(0.54)
6	1/4	MT6-MA-PMBP4-	38.1(1.50)	11.2(0.44)	4.0(0.16)	19.0(0.75)	17.8(0.70)
8	1/4	MT8-MA-PMBP4-	38.9(1.53)	11.2(0.44)	6.4(0.25)	19.0(0.75)	17.8(0.70)
10	1/4	MT10-MA-PMBP4-	38.9(1.53)	11.2(0.44)	6.4(0.25)	19.0(0.75)	17.8(0.70)
10	3/8	MT10-MA-PMBP6-	39.7(1.56)	11.2(0.44)	7.5(0.30)	22.0(0.87)	21.6(0.85)
10	1/2	MT10-MA-PMBP8-	42.9(1.69)	14.2(0.56)	7.5(0.30)	27.0(1.06)	25.9(1.02)
12	1/4	MT12-MA-PMBP4-	43.7(1.72)	11.2(0.44)	6.4(0.25)	19.0(0.75)	17.8(0.70)
12	3/8	MT12-MA-PMBP6-	44.5(1.75)	11.2(0.44)	7.9(0.31)	22.0(0.87)	21.6(0.85)
12	1/2	MT12-MA-PMBP8-	49.2(1.94)	14.2(0.56)	9.1(0.36)	27.0(1.06)	25.9(1.02)
16	1/2	MT16-MA-PMBP8-	50.8(2.00)	14.2(0.56)	11.9(0.47)	27.0(1.06)	25.9(1.02)
18	3/4	MT18-MA-PMBP12-	53.2(2.09)	16.0(0.63)	14.0(0.55)	33.0(1.30)	32.0(1.26)
20	3/4	MT20-MA-PMBP12-	54.0(2.13)	16.0(0.63)	15.1(0.59)	33.0(1.30)	32.0(1.26)
25	1	MT25-MA-PMBP16-	65.1(2.56)	18.3(0.72)	19.8(0.78)	41.0(1.61)	38.9(1.53)
28	1	MT28-MA-PMBP16-	72.7(2.86)	18.3(0.72)	19.8(0.78)	41.0(1.61)	38.9(1.53)
28	1 1/4	MT28-MA-PMBP20-	77.3(3.04)	19.8(0.78)	22.5(0.89)	50.0(1.97)	49.0(1.93)
30	1 1/4	MT30-MA-PMBP20-	80.8(3.18)	19.8(0.78)	24.3(0.96)	50.0(1.97)	49.0(1.93)
32	1 1/4	MT32-MA-PMBP20-	82.1(3.23)	19.8(0.78)	26.5(1.04)	50.0(1.97)	49.0(1.93)
38	1 1/2	MT38-MA-PMBP24-	94.5(3.72)	22.1(0.87)	31.6(1.24)	55.0(2.17)	54.7(2.15)

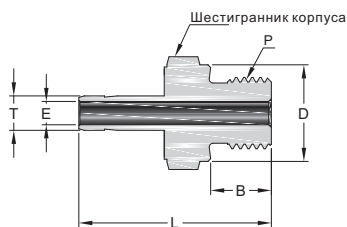

до 25 мм

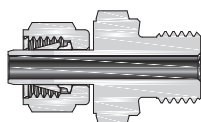

от 28 мм

Трубный адаптер с внутренней резьбой

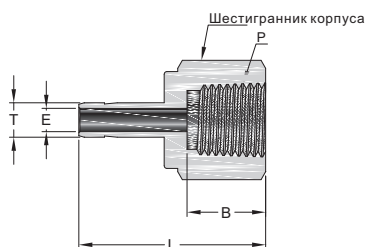

до 1 дюйма

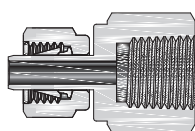

от 1 дюйма

Дюймовая трубка

NPT Резьба

Трубка, дюйм	P-NPT Резьба	Артикул для заказа	Габариты, дюйм (мм)			
			L	B	E	F
1/16	1/8	FT1-FA-FNPT2-	1.07(27.2)	0.41(10.4)	0.03(0.8)	0.56(14.3)
1/8	1/8	FT2-FA-FNPT2-	1.24(31.5)	0.41(10.4)	0.08(2.0)	0.56(14.3)
1/8	1/4	FT2-FA-FNPT4-	1.39(35.3)	0.59(15.0)	0.08(2.0)	0.75(19.1)
3/16	1/8	FT3-FA-FNPT2-	1.25(31.8)	0.41(10.4)	0.11(2.9)	0.56(14.3)
3/16	1/4	FT3-FA-FNPT4-	1.41(35.8)	0.59(15.0)	0.12(3.0)	0.75(19.1)
1/4	1/8	FT4-FA-FNPT2-	1.30(33.0)	0.41(10.4)	0.17(4.3)	0.56(14.3)
1/4	1/4	FT4-FA-FNPT4-	1.46(37.1)	0.59(15.0)	0.17(4.3)	0.75(19.1)
1/4	3/8	FT4-FA-FNPT6-	1.55(39.4)	0.59(15.0)	0.17(4.3)	0.87(22.2)
1/4	1/2	FT4-FA-FNPT8-	1.79(45.5)	0.78(19.8)	0.17(4.3)	1.06(27.0)
5/16	1/8	FT5-FA-FNPT2-	1.34(34.0)	0.41(10.4)	0.22(5.6)	0.56(14.3)
5/16	1/4	FT5-FA-FNPT4-	1.48(37.6)	0.59(15.0)	0.22(5.6)	0.75(19.1)
5/16	3/8	FT5-FA-FNPT6-	1.59(40.4)	0.59(15.0)	0.22(5.6)	0.87(22.2)
3/8	1/8	FT6-FA-FNPT2-	1.35(34.3)	0.41(10.4)	0.27(6.9)	0.56(14.3)
3/8	1/4	FT6-FA-FNPT4-	1.50(38.1)	0.59(15.0)	0.27(6.9)	0.75(19.1)
3/8	3/8	FT6-FA-FNPT6-	1.59(40.4)	0.59(15.0)	0.27(6.9)	0.87(22.2)
3/8	1/2	FT6-FA-FNPT8-	1.84(46.7)	0.78(19.8)	0.27(6.9)	1.06(27.0)
1/2	1/4	FT8-FA-FNPT4-	1.71(43.4)	0.59(15.0)	0.37(9.4)	0.75(19.1)
1/2	3/8	FT8-FA-FNPT6-	1.79(45.5)	0.59(15.0)	0.37(9.4)	0.87(22.2)
1/2	1/2	FT8-FA-FNPT8-	2.04(51.8)	0.78(19.8)	0.37(9.4)	1.06(27.0)
5/8	3/8	FT10-FA-FNPT6-	1.86(47.2)	0.59(15.0)	0.47(11.9)	0.87(22.2)
5/8	1/2	FT10-FA-FNPT8-	2.09(53.1)	0.78(19.8)	0.47(11.9)	1.06(27.0)
3/4	1/2	FT12-FA-FNPT8-	2.08(52.8)	0.78(19.8)	0.58(14.7)	1.06(27.0)
3/4	3/4	FT12-FA-FNPT12-	2.16(54.9)	0.81(20.6)	0.58(14.7)	1.31(33.3)
3/4	1	FT12-FA-FNPT16-	2.30(58.4)	1.00(25.4)	0.58(14.7)	1.63(41.3)
7/8	3/4	FT14-FA-FNPT12-	2.22(56.4)	0.81(20.6)	0.58(14.7)	1.31(33.3)
1	3/4	FT16-FA-FNPT12-	2.39(60.7)	0.81(20.6)	0.80(20.3)	1.31(33.3)
1	1	FT16-FA-FNPT16-	2.53(64.3)	1.00(25.4)	0.80(20.3)	1.63(41.3)
1 1/4	1 1/4	FT20-FA-FNPT20-	3.06(77.7)	1.00(25.4)	1.02(25.9)	2.13(54.0)
1 1/2	1 1/2	FT24-FA-FNPT24-	3.50(88.9)	1.09(27.7)	1.25(31.8)	2.37(60.3)

Дюймовая трубка

ISO Коническая резьба (RT)

Трубка, дюйм	P-RT Резьба	Артикул для заказа	Габариты, дюйм (мм)			
			L	B	E	F
1/4	1/8	FT4-FA-FBT2-	1.30(33.0)	0.41(10.4)	0.17(4.3)	0.56(14.3)
1/4	1/4	FT4-FA-FBT4-	1.45(36.8)	0.59(15.0)	0.17(4.3)	0.75(19.1)
3/8	1/4	FT6-FA-FBT4-	1.50(38.1)	0.59(15.0)	0.27(6.9)	0.75(19.1)
3/8	3/8	FT6-FA-FBT6-	1.59(40.4)	0.59(15.0)	0.27(6.9)	0.87(22.2)
1/2	1/4	FT8-FA-FBT4-	1.71(43.4)	0.59(15.0)	0.37(9.4)	0.75(19.1)
1/2	3/8	FT8-FA-FBT6-	1.80(45.7)	0.59(15.0)	0.37(9.4)	0.87(22.2)
1/2	1/2	FT8-FA-FBT8-	2.05(52.1)	0.78(19.8)	0.37(9.4)	1.06(27.0)

Трубный адаптер с внутренней резьбой

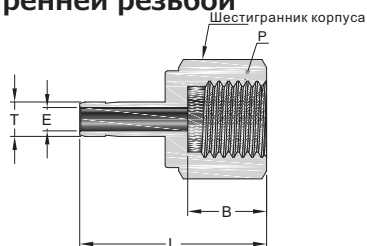

Дюймовая трубка

ISO Цилиндрическая резьба (BP)

Трубка, дюйм	P-BP Резьба	Артикул для заказа	Габариты, дюйм (мм)			
			L	B	E	F
1/8	1/8	FT2-FA-FBP2-	1.17(29.7)	0.40(10.2)	0.08(2.0)	0.56(14.3)
1/4	1/8	FT4-FA-FBP2-	1.25(31.8)	0.40(10.2)	0.17(4.3)	0.56(14.3)
1/4	1/4	FT4-FA-FBP4-	1.50(38.1)	0.60(15.2)	0.17(4.3)	0.75(19.1)
3/8	1/4	FT6-FA-FBP4-	1.55(39.4)	0.60(15.2)	0.27(6.9)	0.75(19.1)
3/8	3/8	FT6-FA-FBP6-	1.57(39.9)	0.60(15.2)	0.27(6.9)	0.94(23.8)
1/2	3/8	FT8-FA-FBP6-	1.78(45.2)	0.60(15.2)	0.38(9.7)	0.94(23.8)
1/2	1/2	FT8-FA-FBP8-	1.95(49.5)	0.72(18.2)	0.38(9.7)	1.06(27.0)

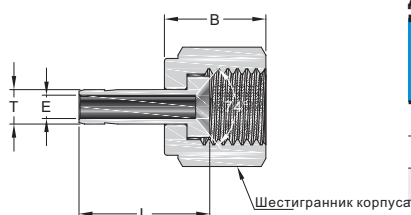

Дюймовая трубка

AN Резьба

Трубка, дюйм	AN Tube Flare Size(in.)	Артикул для заказа	Габариты, дюйм (мм)			
			L	B	E	F
1/8	1/8	FT2-FA-AN2-	0.88(22.4)	0.55(14.0)	0.09(2.4)	0.37(9.5)
1/8	1/4	FT2-FA-AN4-	0.88(22.4)	0.62(15.8)	0.09(2.4)	0.56(14.3)
1/4	1/4	FT4-FA-AN4-	0.96(24.4)	0.62(15.8)	0.18(4.6)	0.56(14.3)
3/8	3/8	FT6-FA-AN6-	1.11(28.1)	0.73(18.5)	0.28(7.1)	0.69(17.5)
1/2	1/2	FT8-FA-AN8-	1.42(36.1)	0.85(21.6)	0.39(9.9)	0.87(22.2)
3/4	3/4	FT12-FA-AN12-	1.49(37.8)	1.03(26.2)	0.58(14.7)	1.25(31.8)

Female Adapters

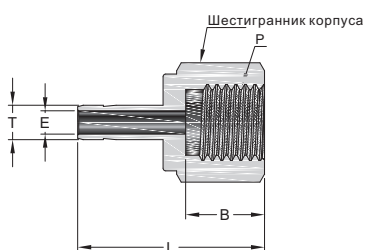

Метрическая трубка

ISO Цилиндрическая резьба (BG)

Трубка, мм	P-BG Резьба	Артикул для заказа	Габариты, мм (дюйм)			
			L	B	E	F
3	1/8	MT3-FA-FBP2-	28.6(1.13)	6.5(0.26)	1.6(0.06)	14.0(0.55)
3	1/4	MT3-FA-FBP4-	33.5(1.32)	10.2(0.40)	1.9(0.07)	19.0(0.75)
4	1/8	MT4-FA-FBP2-	29.4(1.16)	6.5(0.26)	2.0(0.08)	14.0(0.55)
6	1/8	MT6-FA-FBP2-	31.0(1.22)	6.5(0.26)	4.1(0.16)	14.0(0.55)
6	1/4	MT6-FA-FBP4-	35.3(1.39)	10.2(0.40)	4.1(0.16)	19.0(0.75)
6	3/8	MT6-FA-FBP6-	38.4(1.51)	14.2(0.56)	4.1(0.16)	24.0(0.94)
6	1/2	MT6-FA-FBP8-	42.9(1.69)	18.0(0.71)	4.1(0.16)	27.0(1.06)
8	1/4	MT8-FA-FBP4-	33.0(1.30)	10.2(0.40)	5.5(0.22)	19.0(0.75)
8	3/8	MT8-FA-FBP6-	38.9(1.53)	14.2(0.56)	5.6(0.22)	24.0(0.94)
8	1/2	MT8-FA-FBP8-	43.7(1.72)	18.0(0.71)	5.6(0.22)	27.0(1.06)
10	1/4	MT10-FA-FBP4-	34.5(1.36)	10.2(0.40)	5.5(0.22)	19.0(0.75)
10	3/8	MT10-FA-FBP6-	36.1(1.42)	14.2(0.56)	6.5(0.26)	24.0(0.94)
10	1/2	MT10-FA-FBP8-	41.1(1.62)	18.0(0.71)	7.1(0.28)	27.0(1.06)
12	1/4	MT12-FA-FBP4-	41.1(1.62)	10.2(0.40)	5.5(0.22)	19.0(0.75)
12	3/8	MT12-FA-FBP6-	44.7(1.76)	14.2(0.56)	6.5(0.26)	24.0(0.94)
12	1/2	MT12-FA-FBP8-	48.8(1.92)	18.0(0.71)	7.0(0.28)	27.0(1.06)
16	1/2	MT16-FA-FBP8-	49.0(1.93)	18.0(0.71)	7.0(0.28)	27.0(1.06)
18	1/2	MT18-FA-FBP8-	49.3(1.94)	18.0(0.71)	7.0(0.28)	27.0(1.06)

Трубный адаптер с внутренней резьбой

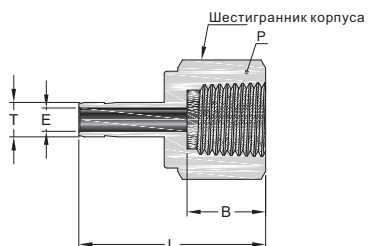

Метрическая трубка

NPT Резьба

Трубка, мм	P-NPT Резьба	Артикул для заказа	Габариты, мм (дюйм)			
			L	B	E	F
3	1/8	MT3-FA-FNPT2-	28.8(1.13)	10.4(0.41)	1.3(0.05)	14.0(0.55)
4	1/8	MT4-FA-FNPT2-	33.3(1.31)	10.4(0.41)	2.0(0.08)	14.0(0.55)
6	1/8	MT6-FA-FNPT2-	32.5(1.28)	10.4(0.41)	4.1(0.16)	14.0(0.55)
6	1/4	MT6-FA-FNPT4-	37.1(1.46)	15.0(0.59)	4.1(0.16)	19.0(0.75)
8	1/8	MT8-FA-FNPT2-	35.1(1.38)	10.4(0.41)	6.4(0.25)	14.0(0.55)
8	1/4	MT8-FA-FNPT4-	37.6(1.48)	15.0(0.59)	5.6(0.22)	19.0(0.75)
8	3/8	MT8-FA-FNPT6-	36.5(1.44)	15.0(0.59)	6.4(0.25)	22.0(0.87)
10	1/4	MT10-FA-FNPT4-	38.1(1.50)	15.0(0.59)	7.1(0.28)	19.0(0.75)
10	3/8	MT10-FA-FNPT6-	40.1(1.58)	15.0(0.59)	7.1(0.28)	22.0(0.87)
10	1/2	MT10-FA-FNPT8-	46.5(1.83)	19.8(0.78)	7.1(0.28)	27.0(1.06)
12	1/4	MT12-FA-FNPT4-	43.7(1.72)	15.0(0.59)	8.8(0.35)	19.0(0.75)
12	3/8	MT12-FA-FNPT6-	42.9(1.69)	15.0(0.59)	9.1(0.36)	22.0(0.87)
12	1/2	MT12-FA-FNPT8-	52.3(2.06)	19.8(0.78)	8.8(0.35)	27.0(1.06)
16	1/2	MT16-FA-FNPT8-	49.2(1.94)	19.8(0.78)	12.7(0.50)	27.0(1.06)
18	3/4	MT18-FA-FNPT12-	52.4(2.06)	20.6(0.81)	14.0(0.55)	32.0(1.26)
20	1/2	MT20-FA-FNPT8-	50.0(1.97)	19.8(0.78)	15.0(0.59)	27.0(1.06)
20	3/4	MT20-FA-FNPT12-	53.2(2.09)	20.6(0.81)	15.1(0.59)	32.0(1.26)
25	1	MT25-FA-FNPT16-	66.7(2.63)	25.4(1.00)	19.8(0.78)	41.0(1.61)

Метрическая трубка

ISO Коническая резьба BSPT)

Трубка, мм	P-BSPT Резьба	Артикул для заказа	Габариты, мм (дюйм)			
			L	B	E	F
3	1/8	MT3-FA-FBT2-	27.8(1.09)	10.4(0.41)	1.8(0.07)	14.0(0.55)
4	1/8	MT4-FA-FBT2-	28.6(1.13)	10.4(0.41)	2.0(0.08)	14.0(0.55)
6	1/8	MT6-FA-FBT2-	33.0(1.30)	10.4(0.41)	4.1(0.16)	14.0(0.55)
8	1/4	MT8-FA-FBT4-	37.6(1.48)	15.0(0.59)	5.6(0.22)	19.0(0.75)
10	1/4	MT10-FA-FBT4-	38.1(1.50)	15.0(0.59)	7.1(0.28)	19.0(0.75)
10	3/8	MT10-FA-FBT6-	36.5(1.44)	15.0(0.59)	7.5(0.30)	22.0(0.87)
10	1/2	MT10-FA-FBT8-	41.3(1.63)	19.8(0.78)	7.5(0.30)	27.0(1.06)
12	1/4	MT12-FA-FBT4-	40.5(1.59)	15.0(0.59)	9.1(0.36)	19.0(0.75)
12	3/8	MT12-FA-FBT6-	43.7(1.72)	15.0(0.59)	9.1(0.36)	22.0(0.87)
12	1/2	MT12-FA-FBT8-	46.8(1.84)	19.8(0.78)	9.1(0.36)	27.0(1.06)
16	1/2	MT16-FA-FBT8-	48.4(1.91)	19.8(0.78)	12.7(0.50)	27.0(1.06)
18	3/4	MT18-FA-FBT12-	52.4(2.06)	20.6(0.81)	14.0(0.55)	32.0(1.26)
20	3/4	MT20-FA-FBT12-	53.2(2.09)	20.6(0.81)	15.1(0.59)	32.0(1.26)
25	1	MT25-FA-FBT16-	66.7(2.63)	25.4(1.00)	19.8(0.78)	41.0(1.61)

Метрическая трубка

ISO Цилиндрическая резьба (BG)

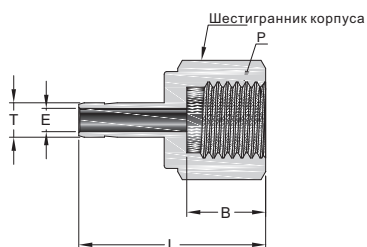

Трубка, мм	P-BG Резьба	Артикул для заказа	Габариты, мм (дюйм)			
			L	B	E	F
6	1/8	MT6-FA-FBP2-	32.0(1.26)	10.2(0.40)	4.1(0.16)	14.0(0.55)
6	1/4	MT6-FA-FBP4-	37.8(1.49)	15.2(0.60)	4.1(0.16)	19.0(0.75)
12	1/2	MT12-FA-FBP8-	49.8(1.96)	18.8(0.74)	8.8(0.35)	27.0(1.06)

Фланцевый переходник

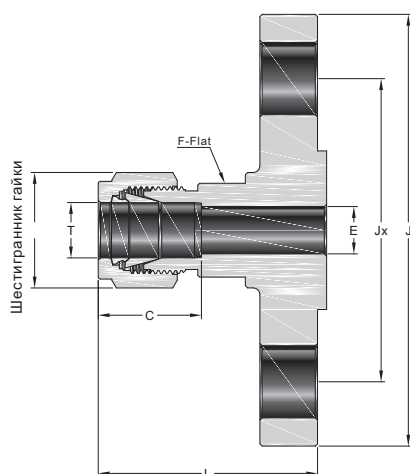

Фланцы по стандарту ASME

Трубка, мм	Размер фланца	Класс	Артикул	Габариты, мм						
				L	J	Jx	E	C	G	F
1/4	1/2	150	F4-FLA-FL8-150-	40.9	88.9	60.5	4.8	15.2	14.3	20.6
3/8	1/2	300	F6-FLA-FL8-150-	45.5	95.3	66.5	7.1	16.8	17.5	20.6
1/2	1/2	150	F8-FLA-FL8-150-	45.2	88.9	60.5	10.4	22.9	22.2	20.6
1/2	1	150	F8-FLA-FL16-150-	48.3	108.0	79.2	10.4	22.9	22.2	20.6
1/2	2	150	F8-FLA-FL32-150-	53.1	152.4	121	10.4	22.9	22.2	20.6
3/4	1	150	F12-FLA-FL16-150-	50.3	108.0	79.2	15.7	24.4	28.6	31.8
1	1	150	F16-FLA-FL16-150-	60.5	108.0	79.2	22.4	31.2	38.1	34.9

Фланцы по стандарту DIN, класс 40

Трубка, мм	Размер фланца	Артикул	Габариты, мм (дюйм)						
			L	J	Jx	E	C	G	F
6	25	M6-FLA-RF25-40C-	47.5(1.87)	115.0(4.53)	85.0(3.35)	4.8(0.19)	15.3(0.60)	14.0(0.55)	20.0(0.79)
12	15	M12-FLA-RF15-40C-	48.5(1.91)	95.0(3.74)	65.0(2.56)	9.5(0.37)	22.8(0.90)	22.0(0.87)	20.0(0.79)
12	25	M12-FLA-RF25-40C-	50.5(1.99)	115.0(4.53)	85.0(3.35)	9.5(0.37)	22.8(0.90)	22.0(0.87)	20.0(0.79)
12	50	M12-FLA-RF50-40C-	55.3(2.18)	165.0(6.50)	125.0(4.92)	9.5(0.37)	22.8(0.90)	22.0(0.87)	20.0(0.79)
18	15	M18-FLA-RF15-40C-	51.8(2.04)	95.0(3.74)	65.0(2.56)	15.1(0.59)	24.4(0.96)	30.0(1.18)	32.0(1.26)
18	25	M18-FLA-RF25-40C-	53.8(2.12)	115.0(4.53)	85.0(3.35)	15.1(0.59)	24.4(0.96)	30.0(1.18)	32.0(1.26)
25	25	M25-FLA-RF25-40C-	64.0(2.52)	115.0(4.53)	85.0(3.35)	21.8(0.86)	31.3(1.23)	38.0(1.50)	35.0(1.38)

Фланцы по стандарту EN, класс 40

Трубка, мм	Размер фланца	Артикул	Габариты, мм (дюйм)						
			L	J	Jx	E	C	G	F
6	25	M6-FLA-RF25E-40B1-	47.5(1.87)	115.0(4.53)	85.0(3.35)	4.8(0.19)	15.3(0.60)	14.0(0.55)	20.0(0.79)
12	15	M12-FLA-RF15E-40B1-	48.5(1.91)	95.0(3.74)	65.0(2.56)	9.5(0.37)	22.8(0.90)	22.0(0.87)	20.0(0.79)
12	25	M12-FLA-RF25E-40B1-	50.5(1.99)	115.0(4.53)	85.0(3.35)	9.5(0.37)	22.8(0.90)	22.0(0.87)	20.0(0.79)
12	50	M12-FLA-RF50E-40B1-	55.3(2.18)	165.0(6.50)	125.0(4.92)	9.5(0.37)	22.8(0.90)	22.0(0.87)	20.0(0.79)
18	15	M18-FLA-RF15E-40B1-	51.8(2.04)	95.0(3.74)	65.0(2.56)	15.1(0.59)	24.4(0.96)	30.0(1.18)	32.0(1.26)
18	25	M18-FLA-RF25E-40B1-	53.8(2.12)	115.0(4.53)	85.0(3.35)	15.1(0.59)	24.4(0.96)	30.0(1.18)	32.0(1.26)
25	25	M25-FLA-RF25E-40B1-	64.0(2.52)	115.0(4.53)	85.0(3.35)	21.8(0.86)	31.3(1.23)	38.0(1.50)	35.0(1.38)

Фланцы по стандарту JIS, класс 10K

Трубка, мм	Размер фланца	Артикул	Габариты, дюйм (мм)						
			L	J	Jx	E	C	G	F
1/4	15	F4-FLA-RF15-10K-	1.66(42.2)	3.74(95.0)	2.76(70.1)	0.19(4.8)	0.60(15.2)	0.56(14.3)	0.81(20.6)
3/8	15	F6-FLA-RF15-10K-	1.72(43.7)	3.74(95.0)	2.76(70.1)	0.28(7.1)	0.66(16.8)	0.69(17.5)	0.81(20.6)
1/2	15	F8-FLA-RF15-10K-	1.83(46.5)	3.74(95.0)	2.76(70.1)	0.41(10.4)	0.90(22.9)	0.87(22.2)	0.81(20.6)
3/4	15	F12-FLA-RF15-10K-	1.91(48.5)	3.74(95.0)	2.76(70.1)	0.62(15.7)	0.96(24.4)	1.13(28.6)	1.25(31.8)
1	25	F16-FLA-RF25-10K-	2.40(61.0)	4.92(125.0)	3.54(89.9)	0.88(22.4)	1.23(31.2)	1.50(38.1)	1.37(34.9)
12mm	15	M12-FLA-RF15-10K-	1.83(46.5)	3.74(95.0)	2.76(70.0)	0.37(9.5)	0.90(22.8)	0.87(22.0)	0.79(20.0)
18mm	15	M18-FLA-RF15-10K-	1.91(48.5)	3.74(95.0)	2.76(70.0)	0.59(15.1)	0.96(24.4)	1.18(30.0)	1.26(32.0)
25mm	25	M25-FLA-RF25-10K-	2.40(61.0)	4.92(125.0)	3.54(90.0)	0.86(21.8)	1.23(31.3)	1.50(38.0)	1.38(35.0)

Переходник с санитарного фланца

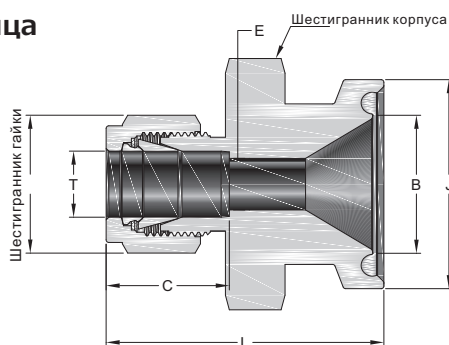

Дюймовая трубка

Трубка, дюйм	Flange Size (in.)	Артикул для заказа	Габариты, дюйм (мм)						
			L	B	C	E	F	J	G
1/4	1/2	F4-SFF-SC8-	1.57(39.9)	0.37(9.4)	0.60(15.2)	0.19(4.8)	1.00(25.4)	0.98(24.9)	0.98(24.9)
1/4	3/4	F4-SFF-SC12-	1.57(39.9)	0.62(15.7)	0.60(15.2)	0.19(4.8)	1.00(25.4)	0.98(24.9)	0.98(24.9)
1/4	1	F4-SFF-SC16-	1.57(39.9)	0.87(22.1)	0.60(15.2)	0.19(4.8)	1.37(34.9)	1.98(50.3)	1.98(50.3)
1/4	1 1/2	F4-SFF-SC24-	1.57(39.9)	1.37(34.8)	0.60(15.2)	0.19(4.8)	1.37(34.9)	1.98(50.3)	1.98(50.3)
3/8	1/2	F6-SFF-SC8-	1.63(41.4)	0.30(7.6)	0.66(16.8)	0.28(7.1)	1.00(25.4)	0.98(24.9)	0.98(24.9)
3/8	3/4	F6-SFF-SC12-	1.63(41.4)	0.62(15.7)	0.66(16.8)	0.28(7.1)	1.00(25.4)	0.98(24.9)	0.98(24.9)
3/8	1	F6-SFF-SC16-	1.63(41.4)	0.87(22.1)	0.66(16.8)	0.28(7.1)	1.37(34.9)	1.98(50.3)	1.98(50.3)
3/8	1 1/2	F6-SFF-SC24-	1.63(41.4)	1.37(34.8)	0.66(16.8)	0.28(7.1)	1.37(34.9)	1.98(50.3)	1.98(50.3)
1/2	1/2	F8-SFF-SC8-	1.74(44.2)	0.30(7.6)	0.90(22.9)	0.37(9.4)	1.00(25.4)	0.98(24.9)	0.98(24.9)
1/2	3/4	F8-SFF-SC12-	1.74(44.2)	0.62(15.7)	0.90(22.9)	0.41(10.4)	1.00(25.4)	0.98(24.9)	0.98(24.9)
1/2	1	F8-SFF-SC16-	1.74(44.2)	0.87(22.1)	0.90(22.9)	0.41(10.4)	1.37(34.9)	1.98(50.3)	1.98(50.3)
1/2	1 1/2	F8-SFF-SC24-	1.74(44.2)	1.37(34.8)	0.90(22.9)	0.41(10.4)	1.37(34.9)	1.98(50.3)	1.98(50.3)
1	1	F16-SFF-SC16-	1.91(48.5)	0.87(22.1)	1.23(31.2)	0.87(22.1)	1.37(34.9)	1.98(50.3)	1.98(50.3)
1	2	F16-SFF-SC32-	2.49(63.2)	1.37(34.8)	1.23(31.2)	0.88(22.4)	2.75(69.9)	2.52(64.0)	2.52(64.0)

Переходник с вакуумного фланца

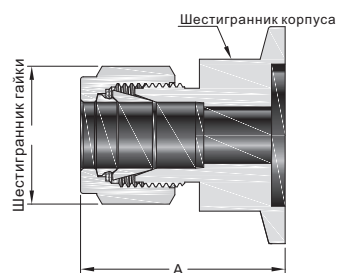

Трубка, дюйм	Flange Size (in.)	Артикул для заказа	A дюйм (мм)	F дюйм (мм)	G дюйм (мм)
1/4	KF10	KF10-VFA-F4-	1.47(37.3)	1/2(12.7)	9/16(14.3)
	KF16	KF16-VFA-F4-			
	KF25	KF25-VFA-F4-			
	KF40	KF40-VFA-F4-			
	KF50	KF50-VFA-F4-			
3/8	KF10	KF10-VFA-F6-	1.63(41.4)	5/8(15.9)	11/16(17.5)
	KF16	KF16-VFA-F6-			
	KF25	KF25-VFA-F6-			
	KF40	KF40-VFA-F6-			
	KF50	KF50-VFA-F6-			
1/2	KF25	KF25-VFA-F8-	1.77(45.0)	13/16(20.6)	7/8(22.2)
	KF40	KF40-VFA-F8-			
	KF50	KF50-VFA-F8-			
3/4	KF25	KF25-VFA-F12-	2.14(54.4)	1 1/16(27.0)	1 1/8(28.6)
	KF40	KF40-VFA-F12-			
	KF50	KF50-VFA-F12-			
1	KF25	KF25-VFA-F16-	2.60(66.0)	1 3/8(34.9)	1 1/2(38.1)
	KF40	KF40-VFA-F16-			
	KF50	KF50-VFA-F16-			

Штуцер под приварку

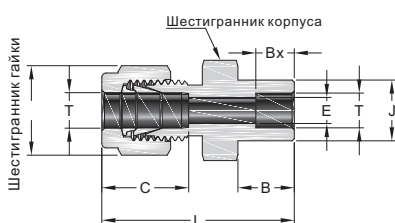

Дюймовая трубка

Tube Socket Weld

Трубка, дюйм	Артикул для заказа	Габариты, мм							
		L	C	G	F	B	E	Vx	J
1/8	F2-WC-FSW2-	29.0	12.7	11.1	11.1	8.6	2.3	2.5	7.9
3/16	F3-WC-FSW3-	29.7	13.7	12.7	11.1	9.5	3.3	4.8	10.7
1/4	F4-WC-FSW4-	33.5	15.2	14.3	12.7	10.4	4.8	7.1	11.2
3/8	F6-WC-FSW6-	37.6	16.8	17.5	15.9	11.9	7.1	7.9	15.7
1/2	F8-WC-FSW8-	41.1	22.9	22.2	20.6	11.9	10.4	9.7	19.1
5/8	F10-WC-FSW10-	41.9	24.4	25.4	23.8	11.9	12.7	10.4	23.4
3/4	F12-WC-FSW12-	43.4	24.4	28.6	27.0	11.9	15.7	11.1	26.7
1	F16-WC-FSW16-	52.6	31.2	38.1	34.9	14.2	22.4	15.7	33.3

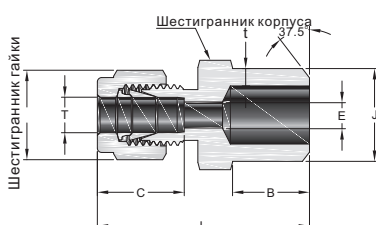

Дюймовая трубка

Pipe Butt Weld

Трубка, дюйм	Pipe Weld Size	Артикул для заказа	Габариты, мм							
			L	C	G	F	E	B	J	t
1/8	1/8	F2-WC-PBW2-	30.5	12.7	11.1	11.1	2.3	9.7	10.3	2.413
3/16	1/8	F3-WC-PBW2-	31.2	13.7	12.7	11.1	3.0	9.7	10.3	2.413
1/4	1/8	F4-WC-PBW2-	32.8	15.2	14.3	12.7	4.8	9.7	10.3	2.413
1/4	1/4	F4-WC-PBW4-	37.8	15.2	14.3	14.3	4.8	14.2	13.7	3.0
5/16	1/8	F5-WC-PBW2-	34.0	16.3	15.9	14.3	5.3	9.7	10.3	2.413
5/16	1/4	F5-WC-PBW4-	38.6	16.3	15.9	14.3	6.4	14.2	13.7	3.0
3/8	1/4	F6-WC-PBW4-	39.9	16.8	17.5	15.9	7.1	14.2	13.7	3.0
3/8	3/8	F6-WC-PBW6-	39.9	16.8	17.5	17.5	7.1	14.2	17.1	3.2
3/8	1/2	F6-WC-PBW8-	46.2	16.8	17.5	22.2	7.1	19.1	21.3	3.7
3/8	3/4	F6-WC-PBW12-	47.8	16.8	17.5	27.0	7.1	19.1	26.7	3.9
1/2	3/8	F8-WC-PBW6-	43.4	22.9	22.2	20.6	10.4	14.2	17.1	3.2
1/2	1/2	F8-WC-PBW8-	49.0	22.9	22.2	22.2	10.4	19.1	21.3	3.7
1/2	3/4	F8-WC-PBW12-	50.5	22.9	22.2	27.0	10.4	19.1	26.7	3.9
5/8	1/2	F10-WC-PBW8-	49.0	24.4	25.4	23.8	12.7	19.1	21.3	3.7
3/4	1/2	F12-WC-PBW8-	50.5	24.4	28.6	27.0	14.0	19.1	21.3	3.7
3/4	3/4	F12-WC-PBW12-	50.5	24.4	28.6	27.0	15.7	19.1	26.7	3.9
1	1	F16-WC-PBW16-	62.2	31.2	38.1	34.9	22.4	23.9	33.4	4.5
1 1/4	1 1/4	F20-WC-PBW20-	77.2	41.1	47.6	44.5	27.7	23.9	42.2	5.1
1 1/2	1 1/2	F24-WC-PBW24-	88.9	50.0	57.2	54.0	34.0	26.2	48.3	5.5

Штуцер под приварку

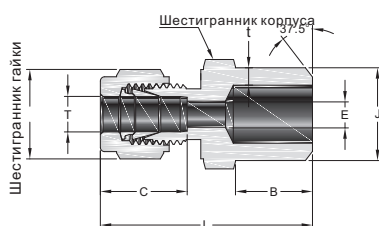

Метрическая трубка

Pipe Butt Weld

Трубка, дюйм	Pipe Weld Size	Артикул для заказа	Габариты, мм						
			L	C	G	F	E	B	J
3	1/8	M3-WC-PBW2-	30.5	12.9	12	12	2.4	9.7	10.3
4	1/8	M4-WC-PBW2-	31.5	13.7	12	12	2.4	9.7	10.3
6	1/8	M6-WC-PBW2-	32.8	15.3	14	14	4.8	9.7	10.3
6	1/4	M6-WC-PBW4-	37.9	15.3	14	14	4.8	14.2	13.7
8	1/8	M8-WC-PBW2-	34.2	16.2	16	15	5.4	9.7	10.3
8	1/4	M8-WC-PBW4-	38.7	16.2	16	15	6.4	14.2	13.7
8	1/2	M8-WC-PBW8-	45.6	16.2	16	22	6.4	19.1	21.3
10	1/4	M10-WC-PBW4-	40.9	17.2	19	18	7.5	14.2	13.7
10	3/8	M10-WC-PBW6-	40.9	17.2	19	18	7.9	14.2	17.2
10	1/2	M10-WC-PBW8-	46.5	17.2	19	22	7.9	19.1	21.3
12	1/4	M12-WC-PBW4-	43.4	22.8	22	22	7.5	14.2	13.7
12	3/8	M12-WC-PBW6-	43.4	22.8	22	22	9.5	14.2	17.1
12	1/2	M12-WC-PBW8-	49.0	22.8	22	22	9.5	19.1	21.3
14	3/8	M14-WC-PBW6-	44.1	24.4	25	24	10.7	14.2	17.1
15	1/2	M15-WC-PBW8-	49.0	24.4	25	24	11.9	19.1	21.3
16	1/2	M16-WC-PBW8-	49.0	24.4	25	24	12.7	19.1	21.3
18	1/2	M18-WC-PBW8-	50.5	24.4	30	27	13.9	19.1	21.3
30	1 1/4	M30-WC-PBW20-	77.2	39.6	50	46	26.2	23.9	42.2
32	1 1/4	M32-WC-PBW20-	79.6	42.0	50	46	28.6	23.9	42.2
38	1 1/2	M38-WC-PBW24-	91.6	49.4	60	55	33.7	26.2	48.3

Weld Elbows

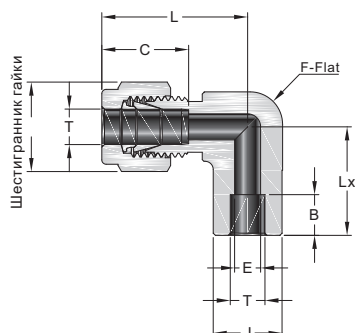

Дюймовая трубка

Tube Socket Weld

Трубка, дюйм	Артикул для заказа	Габариты, мм							
		L	C	G	F	B	E	Lx	J
1/8	F2-WE-FSW2-	16.8	12.7	11.1	9.5	2.5	2.3	16.0	9.7
3/16	F3-WE-FSW3-	18.3	13.7	12.7	11.1	4.8	3.3	17.5	11.2
1/4	F4-WE-FSW4-	26.9	15.2	14.3	12.7	7.1	4.8	19.6	12.7
3/8	F6-WE-FSW6-	30.5	16.8	17.5	15.9	7.9	7.1	23.1	15.7
1/2	F8-WE-FSW8-	36.1	22.9	22.2	20.6	9.7	10.4	25.9	20.6
5/8	F10-WE-FSW10-	29.5	24.4	25.4	27.0	10.4	12.7	29.5	23.9
3/4	F12-WE-FSW12-	39.9	24.4	28.6	27.0	11.2	15.7	29.7	26.9
1	F16-WE-FSW16-	49.0	31.2	38.1	34.9	15.7	22.4	36.8	35.1

Угольники под приварку

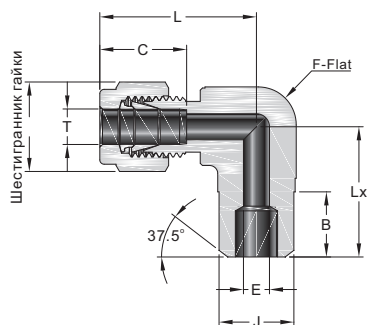

Дюймовая трубка

Pipe Butt Weld

Трубка, дюйм	Pipe Weld Size	Артикул для заказа	Габариты, мм							
			L	C	G	F	B	E	Lx	J
1/8	1/8	F2-WE-PBW2-	23.4	12.7	11.1	11.1	9.7	2.3	18.3	10.3
3/16	1/8	F3-WE-PBW2-	25.7	13.7	12.7	12.7	9.7	3.3	18.8	10.3
1/4	1/8	F4-WE-PBW2-	26.9	15.2	14.3	12.7	9.7	4.8	18.8	10.3
1/4	1/4	F4-WE-PBW4-	26.9	15.2	14.3	12.7	14.2	4.8	23.4	13.7
3/8	1/4	F6-WE-PBW4-	30.5	16.8	17.5	15.9	14.2	7.1	25.4	13.7
1/2	3/8	F8-WE-PBW6-	34.8	22.9	22.2	19.1	14.2	10.4	28.8	17.2
1/2	1/2	F8-WE-PBW8-	36.1	22.9	22.2	20.6	19.1	10.4	33.0	21.3
5/8	1/2	F10-WE-PBW8-	36.3	24.4	25.4	23.8	19.1	12.7	35.1	21.3
3/4	3/4	F12-WE-PBW12-	39.9	24.4	28.6	27.0	19.1	15.7	36.8	26.7
1	3/4	F16-WE-PBW12-	49.3	31.2	38.1	34.9	19.1	22.4	41.9	26.7
1	1	F16-WE-PBW16-	49.3	31.2	38.1	34.9	20.6	22.4	46.7	33.4

Гайки

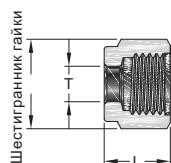

Дюймовая трубка

Трубка, дюйм	Артикул для заказа	Габариты, дюйм (мм)	
		L	G
1/16	N-F1-	0.31(7.9)	0.31(7.9)
1/8	N-F2-	0.47(11.9)	0.44(11.1)
3/16	N-F3-	0.47(11.9)	0.50(12.7)
1/4	N-F4-	0.50(12.7)	0.56(14.3)
5/16	N-F5-	0.53(13.5)	0.63(15.9)
3/8	N-F6-	0.56(14.2)	0.69(17.5)
1/2	N-F8-	0.69(17.5)	0.87(22.2)
5/8	N-F10-	0.69(17.5)	1.00(25.4)
3/4	N-F12-	0.69(17.5)	1.13(28.6)
7/8	N-F14-	0.69(17.5)	1.25(31.8)
1	N-F16-	0.81(20.6)	1.50(38.1)
1 1/8	N-F18-	1.21(30.8)	1.81(46.0)
1 1/4	N-F20-	1.25(31.8)	1.87(47.6)
1 1/2	N-F24-	1.50(38.1)	2.25(57.2)

Метрическая трубка

Трубка, мм	Артикул для заказа	Габариты, мм (дюйм)	
		L	G
2	N-M2-	11.9(0.47)	12.0(0.47)
3	N-M3-	11.9(0.47)	12.0(0.47)
4	N-M4-	11.9(0.47)	12.0(0.47)
6	N-M6-	12.7(0.50)	14.0(0.55)
8	N-M8-	13.5(0.53)	16.0(0.63)
10	N-M10-	15.1(0.59)	19.0(0.75)
12	N-M12-	17.4(0.69)	22.0(0.87)
14	N-M14-	17.4(0.69)	25.0(0.98)
15	N-M15-	17.4(0.69)	25.0(0.98)
16	N-M16-	17.4(0.69)	25.0(0.98)
18	N-M18-	17.4(0.69)	30.0(1.18)
20	N-M20-	17.4(0.69)	32.0(1.26)
22	N-M22-	17.4(0.69)	32.0(1.26)
25	N-M25-	20.6(0.81)	38.0(1.50)
28	N-M28-	30.6(1.20)	46.0(1.81)
30	N-M30-	32.7(1.29)	50.0(1.97)
32	N-M32-	34.4(1.35)	50.0(1.97)
38	N-M38-	40.6(1.60)	60.0(2.36)

Гайки

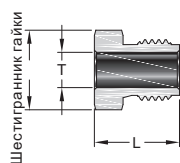

Дюймовая трубка

Трубка, дюйм	Артикул для заказа	Габариты, дюйм (мм)	
		L	G
1/16	MN-F1-	0.38(9.7)	0.25(6.4)
1/8	MN-F2-	0.53(13.5)	0.37(9.5)
1/4	MN-F4-	0.62(15.7)	0.50(12.7)
1/2	MN-F8-	0.87(22.1)	0.94(23.8)

Метрическая трубка

Трубка, мм	Артикул для заказа	Габариты, мм (дюйм)	
		L	G
3	MN-M3-	13.5(0.53)	10.0(0.39)
6	MN-M6-	15.7(0.62)	14.0(0.55)
10	MN-M10-	22.1(0.87)	22.0(0.87)
12	MN-M12-	22.1(0.87)	24.0(0.94)

Передние обжимные кольца



Дюймовая трубка

Трубка, дюйм	Артикул для заказа
1/16	FF-F1
1/8	FF-F2
3/16	FF-F3
1/4	FF-F4
5/16	FF-F5
3/8	FF-F6
1/2	FF-F8
5/8	FF-F10
3/4	FF-F12
7/8	FF-F14
1	FF-F16
1 1/8	FF-F18
1 1/4	FF-F20
1 1/2	FF-F24

Метрическая трубка

Трубка, мм	Артикул для заказа
2	FF-M2
3	FF-M3
4	FF-M4
6	FF-M6
8	FF-M8
10	FF-M10
12	FF-M12
14	FF-M14
15	FF-M15
16	FF-M16
18	FF-M18
20	FF-M20
22	FF-M22
25	FF-M25
28	FF-M28
30	FF-M30
32	FF-M32
38	FF-M38

Задние обжимные кольца



Дюймовая трубка

Трубка, дюйм	Артикул для заказа
1/16	RF-F1
1/8	RF-F2
3/16	RF-F3
1/4	RF-L4
5/16	RF-F5
3/8	RF-L6
1/2	RF-F8
5/8	RF-F10
3/4	RF-F12
7/8	RF-F14
1	RF-F16
1 1/8	RF-F18
1 1/4	RF-F20
1 1/2	RF-F24

Метрическая трубка

Трубка, мм	Артикул для заказа
2	RF-M2
3	RF-M3
4	RF-M4
6	RF-M6
8	RF-M8
10	RF-M10
12	RF-M12
14	RF-M14
15	RF-M15
16	RF-M16
18	RF-M18
20	RF-M20
22	RF-M22
25	RF-M25
28	RF-M28
30	RF-M30
32	RF-M32
38	RF-M38

Комплект обжимных колец и гаек

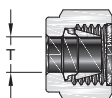

Дюймовая трубка

Трубка, дюйм	Артикул для заказа
1/16	NFR-F1
1/8	NFR-F2
3/16	NFR-F3
1/4	NFR-F4
5/16	NFR-F5
3/8	NFR-F6
1/2	NFR-F8
5/8	NFR-F10
3/4	NFR-F12
7/8	NFR-F14
1	NFR-F16
1 1/8	NFR-F18
1 1/4	NFR-F20
1 1/2	NFR-F24

Метрическая трубка

Трубка, мм	Артикул для заказа
2	NFR-M2
3	NFR-M3
4	NFR-M4
6	NFR-M6
8	NFR-M8
10	NFR-M10
12	NFR-M12
14	NFR-M14
15	NFR-M15
16	NFR-M16
18	NFR-M18
20	NFR-M20
22	NFR-M22
25	NFR-M25
28	NFR-M28
30	NFR-M30
32	NFR-M32
38	NFR-M38

Комплект обжимных колец и гаек

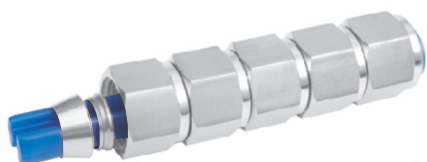

Каждый комплект состоит из 5 гаек, 5 передних колец и 5 задних.

Дюймовая трубка

Трубка, дюйм	Артикул для заказа
1/16	NFS-F1-
1/8	NFS-F2-
3/16	NFS-F3-
1/4	NFS-F4-
5/16	NFS-F5-
3/8	NFS-F6-
1/2	NFS-F8-
5/8	NFS-F10-
3/4	NFS-F12-

Метрическая трубка

Трубка, мм	Артикул для заказа
2	NFS-M2-
3	NFS-M3-
4	NFS-M4-
6	NFS-M6-
8	NFS-M8-
10	NFS-M10-
12	NFS-M12-
14	NFS-M14-
15	NFS-M15-
16	NFS-M16-
18	NFS-M18-

Набор обжимных колец



Каждый набор обжимных колец состоит из 10 гаек, 10 передних колец и 10 задних.

Дюймовая трубка

Трубка, дюйм	Артикул для заказа
1/16	FRS-F1-
1/8	FRS-F2-
3/16	FRS-F3-
1/4	FRS-F4-
5/16	FRS-F5-
3/8	FRS-F6-
1/2	FRS-F8-
5/8	FRS-F10-
3/4	FRS-F12-

Метрическая трубка

Трубка, мм	Артикул для заказа
2	FRS-M2-
3	FRS-M3-
4	FRS-M4-
6	FRS-M6-
8	FRS-M8-
10	FRS-M10-
12	FRS-M12-
14	FRS-M14-
15	FRS-M15-
16	FRS-M16-
18	FRS-M18-

Вставки для мягких трубок

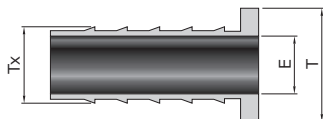

Дюймовая трубка

Трубка, дюйм	Tx Трубка, дюйм	Артикул для заказа	E дюйм (мм)
3/16	1/8	ISPF-3-2-	0.09(2.3)
1/4	1/8	ISPF-4-2-	0.09(2.3)
1/4	0.17	ISPF-4-017-	0.11(2.8)
1/4	3/16	ISPF-4-3-	0.14(3.5)
5/16	1/8	ISPF-5-2-	0.09(2.3)
5/16	3/16	ISPF-5-3-	0.12(3.0)
5/16	1/4	ISPF-5-4-	0.19(4.8)
3/8	3/16	ISPF-6-3-	0.12(3.0)
3/8	1/4	ISPF-6-4-	0.19(4.8)
1/2	1/4	ISPF-8-4-	0.19(4.8)
1/2	3/8	ISPF-8-6-	0.31(7.9)
5/8	3/8	ISPF-10-6-	0.31(7.9)
5/8	1/2	ISPF-10-8-	0.44(11.1)
3/4	1/2	ISPF-12-8-	0.44(11.1)
3/4	5/8	ISPF-12-10-	0.56(14.2)
1	3/4	ISPF-16-12-	0.69(17.5)

Метрическая трубка

Трубка, мм	Tx Трубка, мм	Артикул для заказа	E мм (дюйм)
6	4	ISPM-6-4-	2.8(0.11)
8	6	ISPM-8-6-	4.4(0.17)
10	8	ISPM-10-8-	6.4(0.25)
12	8	ISPM-12-8-	6.4(0.25)
12	10	ISPM-12-10-	8.3(0.33)

Комбинированные уплотнительные кольца



Размер резьбы	Артикул для заказа	Габариты, дюйм (мм)		
		T	E	H
1/8	BS-2	0.63(16.0)	0.41(10.4)	0.08(2.0)
1/4	BS-4	0.81 (20.6)	0.54 (13.7)	
3/8	BS-6	0.94 (23.9)	0.68 (17.3)	
1/2	BS-8	1.13 (28.7)	0.85 (21.6)	0.10(2.5)
3/4	BS-12	1.38 (35.1)	1.06 (26.9)	
1	BS-16	1.69 (42.9)	1.33 (33.8)	

Размер резьбы	Артикул для заказа	Габариты, мм (дюйм)		
		T	E	H
M8 x 1	BS-MS8-	13.0(0.51)	8.7(0.34)	1.5(0.06)
M10 x 1	BS-MS10-	16.0(0.63)	10.7(0.42)	
M12 x 1.5	BS-MS12-	18.0(0.63)	12.7(0.42)	
M14 x 1.5	BS-MS14-	22.0(0.71)	14.7(0.50)	
M16 x 1.5	BS-MS16-	24.0(0.87)	16.7(0.66)	
M18 x 1.5	BS-MS18-	26.0(0.94)	18.7(0.74)	
M20 x 1.5	BS-MS20-	28.0(1.02)	20.7(0.81)	
M22 x 1.5	BS-MS22-	30.0(1.10)	22.7(0.89)	2.0(0.08)
M24 x 1.5	BS-MS24-	32.0(1.20)	24.7(1.00)	
M27 x 2	BS-MS27-	36.0(1.30)	27.2(1.10)	
M30 x 2	BS-MS30-	39.0(1.40)	30.7(1.20)	
M33 x 2	BS-MS33-	42.0(1.50)	33.7(1.30)	2.5(0.10)
M36 x 2	BS-MS36-	48.0(1.70)	37.0(1.50)	
M39 x 2	BS-MS39-	51.0(1.90)	40.0(1.60)	
M42 x 2	BS-MS42-	53.0(2.00)	42.7(1.70)	3.0(0.12)
M45 x 2	BS-MS45-	57.0(2.10)	46.0(1.80)	
M48 x 2	BS-MS48-	59.0(2.20)	48.7(1.90)	

Уплотнительные кольца BS служат для уплотнения ISO резьб.

Уплотнительное кольцо состоит непосредственно из кольца из нержавеющей или углеродистой стали и вставки из FKM или Buna.

Информация для заказа

Для заказа, добавьте в конце артикула обозначение материала.

Кольцо		Обозначение
Внешнее	Внутреннее	
Нержавеющая сталь	FKM	316, 304
Углеродистая сталь	Buna-N	CS

Пример:

Для заказа уплотнительного кольца под резьбу 1/8" дюйма из углеродистой стали со вставкой из Buna, номер для заказа BS-2-CS

Кольца BS используются с фитингами BS.

Уплотнительные медные кольца для внешней резьбы

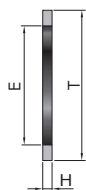

ISO Размер цилиндрической резьбы	Артикул для заказа	Габариты, дюйм (мм)		
		T	E	H
1/8	BP-2-	0.59(15.0)	0.39(9.9)	0.04(1.0)
1/4	BP-4-	0.75(19.1)	0.52(13.2)	0.06(1.5)
3/8	BP-6-	0.91(23.1)	0.66(16.8)	
1/2	BP-8-	1.06(26.9)	0.83(21.1)	0.08(2.0)
3/4	BP-12-	1.30(33.0)	1.05(26.7)	
1	BP-16-	1.58(40.1)	1.31(33.2)	

Metric Thread Size	Артикул для заказа	Габариты, мм (дюйм)		
		T	E	H
M8 x 1	BP-MS8-	13.2(0.52)	8.2(0.32)	1.5(0.06)
M10 x 1	BP-MS10-	15.2(0.60)	10.2(0.40)	
M12 x 1.5	BP-MS12-	18.2(0.60)	12.2(0.40)	2.0(0.08)
M14 x 1.5	BP-MS14-	20.2(0.72)	14.2(0.48)	
M16 x 1.5	BP-MS16-	22.2(0.80)	16.2(0.64)	
M18 x 1.5	BP-MS18-	24.2(0.87)	18.2(0.72)	
M20 x 1.5	BP-MS20-	26.2(0.95)	20.2(0.80)	
M22 x 1.5	BP-MS22-	28.2(1.03)	22.2(0.87)	
M24 x 1.5	BP-MS24-	30.2(1.10)	24.2(1.00)	2.5(0.10)
M27 x 2	BP-MS27-	33.3(1.20)	27.2(1.10)	
M30 x 2	BP-MS30-	37.3(1.30)	30.2(1.20)	
M33 x 2	BP-MS33-	40.3(1.50)	33.2(1.30)	
M36 x 2	BP-MS36-	43.3(1.60)	36.2(1.40)	
M39 x 2	BP-MS39-	47.3(1.70)	39.2(1.50)	
M42 x 2	BP-MS42-	50.3(1.90)	42.2(1.70)	
M45 x 2	BP-MS45-	53.3(2.00)	45.2(1.80)	
M48 x 2	BP-MS48-	56.3(2.10)	48.2(1.90)	

Кольца BS служат для уплотнения резьб ISO.

Кольца BP используются с фитингами BP и вставки из FKM или Viton.

Комбинированные уплотнительные кольца

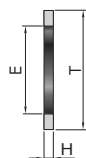

ISO Размер цилиндрической резьбы	Артикул для заказа	Габариты, дюйм (мм)		
		T	E	H
1/4	BG-4	0.42(10.7)	0.30(7.6)	0.07(1.8)
3/8	BG-6	0.56(14.2)	0.34(8.6)	0.09(2.3)
1/2	BG-8	0.70(17.8)	0.36(9.1)	0.10(2.5)

ISO Размер цилиндрической резьбы	Артикул для заказа	Габариты, дюйм (мм)		
		T	E	H
M10 x 1	BG-MS10-	8.3(0.33)	3.3(0.13)	1.5(0.06)
M12 x 1.5	BG-MS12-	9.7(0.38)	5.4(0.21)	2.0(0.08)
M14 x 1.5	BG-MS14-	11.7(0.38)	6.4(0.21)	
M16 x 1.5	BG-MS16-	13.7(0.46)	8.4(0.25)	
M18 x 1.5	BG-MS18-	15.7(0.54)	10.0(0.39)	
M20 x 1.5	BG-MS20-	17.6(0.62)	11.4(0.45)	
M22 x 1.5	BG-MS22-	19.6(0.69)	13.4(0.53)	
M24 x 1.5	BG-MS24-	21.6(0.77)	14.8(0.58)	2.5(0.10)
M27 x 2	BG-MS27-	24.0(0.90)	13.9(0.50)	
M30 x 2	BG-MS30-	27.0(0.90)	19.5(0.80)	
M33 x 2	BG-MS33-	30.0(1.10)	21.5(0.80)	
M36 x 2	BG-MS36-	33.0(1.20)	23.5(0.90)	
M39 x 2	BG-MS39-	36.0(1.30)	24.5(1.00)	
M42 x 2	BG-MS42-	38.9(1.40)	29.5(1.20)	
M45 x 2	BG-MS45-	41.9(1.50)	30.0(1.20)	
M48 x 2	BG-MS48-	44.9(1.60)	32.5(1.30)	

Информация для заказа

Для заказа, добавьте в конце артикула обозначение материала.

Материал	Обозначение
Медь	BR
Нержавеющая сталь 316	316L
PTFE	T

Вулканизированное волокно и PTFE не могут применяться в кольцах BG.

Пример:

BP-8-BR, BG-4-316, BG-MS14-BR.

Уплотнительные кольца из эластомеров



Кольца для фитингов с прямой резьбой SAE/MS

SAE/MS Размер резьбы	Артикул	Материал
5/16-24	FKM9-902	90 Durometer Fluorocarbon FKM
3/8-24	FKM9-903	
7/16-20	FKM9-904	
1/2-20	FKM9-905	
9/16-18	FKM9-906	
3/4-16	FKM9-908	
7/8-14	FKM9-910	
1 1/16-12	FKM9-912	
1 3/16-12	FKM9-914	
1 5/16-12	FKM9-916	
1 5/8-12	FKM9-920	
1 7/8-12	FKM9-924	

Кольца для фитингов

NPT/ISO Размер резьбы	Артикул	Материал
1/8	NBR7-013	70 Durometer NBR
1/4	NBR7-113	
3/8	NBR7-116	
1/2	NBR7-118	

Кольца для позиционируемых фитингов

ISO Parallel Размер резьбы	Артикул	Материал
1/8	FKM9-502	90 Durometer Fluorocarbon FKM
1/4	FKM9-111	
3/8	FKM9-113	
1/2	FKM9-508	
3/4	FKM9-119	
1	FKM9-217	

Кольца для SAE резьб

SAE/MS Размер резьбы	Артикул	Материал
5/16-24	NBR7-011	70 Durometer NBR
3/8-24	NBR7-012	
7/16-20	NBR7-013	
1/2-20	NBR7-112	
9/16-18	NBR7-113	
3/4-16	NBR7-116	
1 1/16-12	NBR7-121	
1 5/16-12	NBR7-125	

Как заказать

F8		— MBT —		F8		— NPT8 —		316	
Тип 1 части	Размер 1 выхода	Обозначение конфигурации		Размер 2 выхода	Размер 2 выхода	Выходы 3 и 4		Материал	
M Метрическая трубка	1 1/16 дюйма	MC	Штуцер с внешней резьбой	Такой же как и 1 части или:	Такой как	Такие же как 1 выход		316 Нержавеющая сталь марки 316 316L Нержавеющая сталь марки 316L 304 Нержавеющая сталь марки 304 304L Нержавеющая сталь марки 304L A20 Сплав 20 A400 Сплав 400 A600 Сплав 600 A825 Сплав 825 A276 Сплав C276 DU7 Дуплекс 2507 BR Латунь CS Углеродистая сталь TI Титан	
	2 1/8 дюйма или 2 мм	BMC	Штуцер с внешней резьбой и монтажом на панель	FNPT Внутренняя NPT	и 1 часть или:				
F Дюймовая трубка	3 3/16 дюйма или 3 мм	TC	Фитинги с внешней резьбой для термопар	NPT Внешняя NPT	5 M5 x 0.8 или 5/16-24				
	4 1/4 дюйма или 4 мм	FC	Фитинг с внутренней резьбой	NPTO Уплотнительные кольца из эластомеров Внешняя NPT	6 M6 x 1 или 3/8-24				
	5 5/16 дюйм	BFC	Фитинг с внутренней резьбой с креплением на панель	FBT Внутренняя BSPT	7 7/16-20				
	6 3/8 дюйма или 6 мм	U	Муфты	MBT Внешняя BSPT	8 M8 x 1 или 1/2-20				
	8 1/2 дюйма или 8 мм	BU	Муфта с монтажом на панель	MBTO Уплотнительные кольца из эластомеров с внешней BSPT	9 9/16-18				
	10 5/8 дюйма или 10 мм	ME	Угольник с внешней резьбой	FBP Внутренняя BSPP	10 M10 x 1				
	12 3/4 дюйма или 12 мм	45ME	Угольник под 45° с внешней резьбой	MBVP Внешняя BSPP(for BP)	12 M12 x 1.5 или 3/4-16				
	14 7/8 дюйма или 14 мм	PME	Позиционируемые угольник с внешней резьбой	MBS Внешняя BSPP(for BS)	14 M14 x 1.5 или 7/8-14				
	15 15 мм	FE	Угольник с внутренней резьбой	MBP Внешняя BSPP(for BG)	16 M16 x 1.5				
	16 1 дюйм или 16 мм	UE	Соединительный угольник	FMS Внутренняя ISO	17 1 1/16-12				
	18 1 1/8 дюйма или 18 мм	MRT	Тройник с внешней резьбой сбоку	MS Внешняя ISO (for BG)	18 M18 x 1.5				
	20 1 1/4 дюйм или 20 мм	MBT	Тройник с внешней резьбой снизу	BPMS Внешняя ISO (for BP)	19 1 3/16-12				
	22 22 мм	PMRT	Позиционируемый Тройник с внешней резьбой сбоку	BSMS Внешняя ISO (for BS)	20 M20 x 1.5				
	24 1 1/2 дюйм или 24 мм	PMBT	Позиционируемый Тройник с внешней резьбой снизу	OMS Уплотнительные кольца из эластомеров с внешней ISO	21 1 5/16 -12				
	25 25 мм	FRT	Тройник с внутренней резьбой сбоку	FST Внутренняя SAE	22 M22 x 1.5				
	28 28 мм	FBT	Тройник с внутренней резьбой снизу	MST Внешняя SAE (for BG)	24 M24 x 1.5				
	30 30 мм	UT	Соединительный тройник	BPST Внешняя SAE (for BP)	26 1 5/8 -12				
	32 2 дюйма или 32 мм	UC	Соединительная крестовина	BSST Внешняя SAE (for BS)	27 M27 x 2				
	38 38 мм	CA	Колпак	OST Уплотнительные кольца из эластомеров с внешней SAE	30 1 7/8 -12				
	50 50 мм	PL	Заглушка	PPT Позиционируемые BSP Цилиндрическая резьба					
		R	Переходники с трубным ад аптером	PMS Позиционируемые ISO Цилиндрическая резьба					
		PC	Соединитель для фитингов	PST Позиционируемые SAE Цилиндрическая резьба					
		MA	Трубный адаптер с внешней резьбой	AN 37° Flare					
		FA	Трубный адаптер с внутренней резьбой	FSW Под приварку вращаемый дюйм					
		WC	Штуцер под приварку	FBW Под приварку встык дюйм					
		WE	Угольники под приварку	MSW Под приварку вращаемый метрический					
		FLA	Фланцевый переходник	MBW Под приварку встык метрический					
		SFF	Переходник с санитарного фланца						
		N	Гайка						
		MN	Гайки						
		RF	Задние обжимные кольца						
		FF	Передние обжимные кольца						
		FR	Обжимные кольца						
		NFR	Комплект обжимных колец и гайки						

